



Lichtbauelemente

Translucent Building Elements



LICHTBAUELEMENTE



Lichtbauelemente

Vorteile

- Polycarbonat ist ein glasklares hochschlagzähes Thermoplast
- Temperaturbeständigkeit von - 40 bis +115°C, kurzfristig bis zu 130°C
- Schlagzähigkeit nahezu gleichbleibend über diesen Temperaturbereich
- gutes Langzeitverhalten durch UV-Schutz
- 10 Jahre Garantie gegen Vergilbung - Alterung - Hagelschlag
- lichtdurchlässig, wärmedämmend

Anwendungen

- Fassadenverkleidungen
- Sport- und Gewerbehallen
- Dachkonstruktionen
- Shedverglasungen
- Überdachungen
- Innenanwendungen wie Messebau, Raumteiler
- Wand- und Dachsanierung
- Vorhangfassaden
- Fensterverglasung

Verfügbare Stärken / Produktionsprogramm

40	Panel	Up-Wert W/m ² K**	Gewicht kg/m ²	Baubreite (mm)
	2540-4	1,3 - 1,5 W/m ² K	ca. 4,0 kg/m ²	500 (+1/-1%)
	2540-4 MC	1,3 - 1,6 W/m ² K	ca. 4,0 kg/m ²	500 (+1/-1%)
	2540-6	1,1 - 1,2 W/m ² K	ca. 4,2 kg/m ²	500 (+1/-1%)
	2540-7	1,0 - 1,1 W/m ² K	ca. 4,3 kg/m ²	500 (+1/-1%)
	2540-10	1,0 W/m ² K	ca. 4,2 kg/m ²	500 (+1/-1%)

PC 2540-4



Farben

Standard: kristall / opal / Bicolor*

Color-Ausführung: ab 300 m²

Bicolor-Ausführung: ab 150 m²

Auf Anfrage auch UV-Coextrusion auf Innen- und Außenseite des Paneels möglich!

PC 2540-4 MC



Farben

Standard: kristall / opal

Color-Ausführung: ab 300 m²

PC 2540-6



Farben

Standard: kristall / opal / color*

Color-Ausführung: ab 300 m²

PC 2540-7

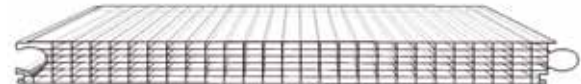

Farben

Standard: kristall / opal / decocolor*

Color-Ausführung: ab 450 m²

Decocolor-Ausführung: ab 150 m²

PC 2540-10

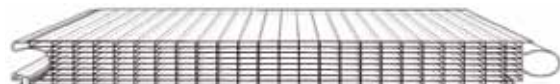

Farben

Standard: kristall / opal

Color-Ausführung: ab 300 m²





RT-Thermolight
RT-Thermolight

U-Paneele
U-panels

Fenster
Windows

Do it yourself
Do it yourself

50	Paneel	Up-Wert W/m ² K**	Gewicht kg/m ²	Baubreite (mm)
	2550-10	0,80 - 0,92 W/m ² K	ca. 5,0 kg/m ²	495 (+1/-1%)

PC 2550-10

Farben
Standard: kristall / opal / color*

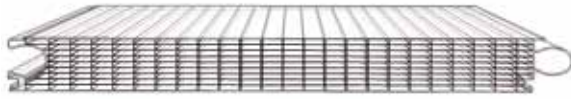

Duocolor-Ausführung: ab 300 m²
Color-Ausführung: ab 300 m²

60	Paneel	Up-Wert W/m ² K**	Gewicht kg/m ²	Baubreite (mm)
	2560-12	0,71 - 0,77 W/m ² K	ca. 5,8 kg/m ²	500 (+1/-1%)

PC 2560-12

Farben
Standard: kristall / opal

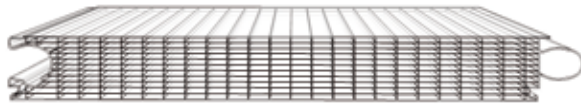

Color-Ausführung: ab 300 m²

Farben

Color: vollflächige Einfärbung des Paneels



Bicolor: Einfärbung der Innenseite



Decocolor: Einfärbung der Außenseite



Duocolor: Einfärbung bis zur Paneelmitte



* Mindestmengen, alle weiteren Farbkombinationen sowie unsere vielzähligen Ausführungen entnehmen Sie bitte den technischen Handbüchern.

** Up-Werte

in Abhängigkeit horizontaler oder vertikaler Einbausituation im Innen- und Außenbereich nach DIN EN ISO 6946:2008 / DIN EN ISO 10077-2:2008

Paneele

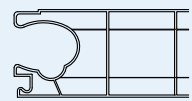

40

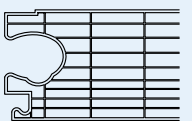
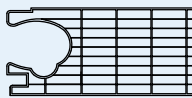
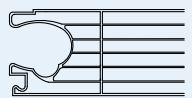
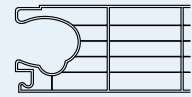
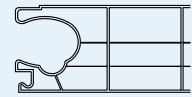

50

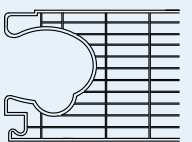

60

 Lichtbauelemente

Soganker

40



40

System	Flachsoganker
PC 2540-x AF 50	49404050
PC 2540-x AF 100	494040100

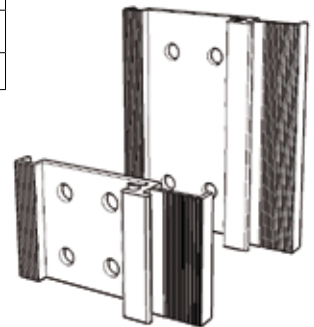
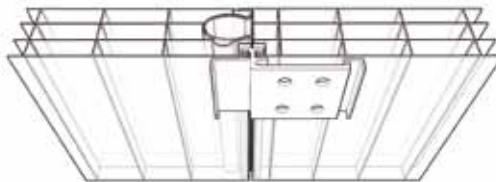

50

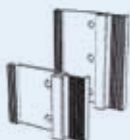

50

System	Flachsoganker
PC 2550-10 AF 60	49405060
PC 2550-10 AF 120	494050120

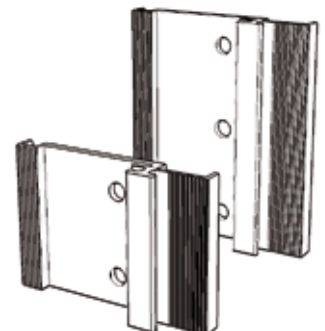
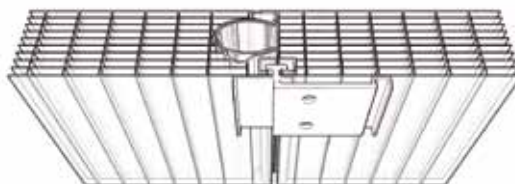



RT-Thermolight
RT-Thermolight

U-Paneele
U-Panels

Fenster
Windows

Do it yourself
Do it yourself

Materialeigenschaften

Die RODECA Flachsoganker werden aus stranggepresstem Aluminium (EN AW-6060, Zustand T 66 nach DIN EN 755-2) gefertigt, anschließend zugeschnitten, gestanzt und trovalisiert.

60	System	Flachsoganker
	PC 2560-12 AF 60	49405060
	PC 2560-12 AF 120	494050120

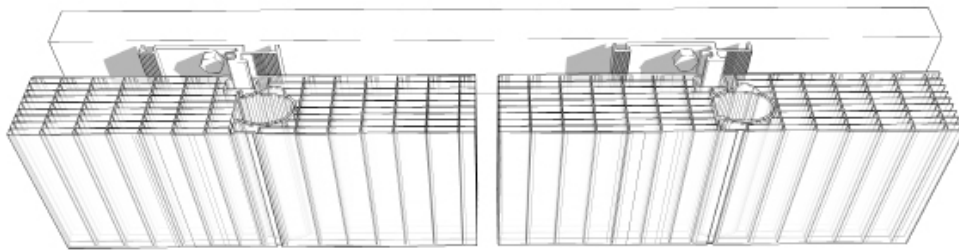
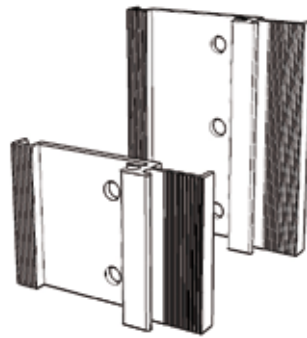
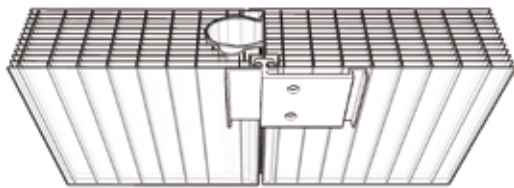

Soganker



60



Lichtbauelemente



Hohlkammerscheiben
Multi Wall Sheets



Multi-Funktions-Paneele
Multi Function Panels



Lichtbauelemente

Thermisch getrennte Aluminiumprofile

Das thermisch getrennte Rahmensystem besteht aus stranggepressten Aluminiumprofilen aus Aluminium EN AW-6060, Zustand T66 nach DIN EN 755-2. Die Isolierstege bestehen aus glasfaserverstärktem Polyamid PA66 mit einem Glasfaseranteil von 25%. Die Dichtungen bestehen standardmäßig aus grauem TPE.

Nicht thermisch getrennte Aluminiumprofile

Das nicht thermisch getrennte Rahmensystem besteht aus stranggepressten Aluminiumprofilen aus Aluminium EN AW-6060, Zustand T66 nach DIN EN 755-2. Die Dichtungen bestehen standardmäßig aus grauem TPE.

Rahmensysteme

Unsere Rahmensysteme zur Einfassung der Paneele gibt es in thermisch getrennter oder nicht thermisch getrennter Ausführung. Sie eignen sich für die Umsetzung vielzähliger Konstruktionen und sind in nahezu jeder Montagesituation einsetzbar. Zudem sind unsere Profile anwendungsfreundlich und ermöglichen eine schnelle und einfache Montage.



Montagesituation Vorhangfassade



Montagesituation in Laibung





RT-Thermolight
RT-Thermolight

U-Paneele
U-Panels

Fenster
Windows

Do it yourself
Do it yourself



Rahmenprofile

40

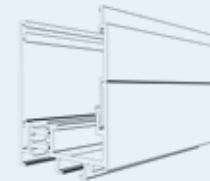
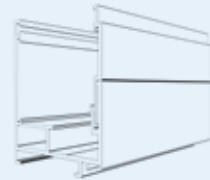

50

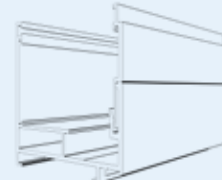

60

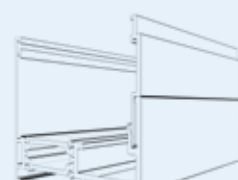

Beispiel für thermisch getrennte Profile

umlaufendes zweiteiliges Aluminiumprofil mit innerer und äußerer Dichtung

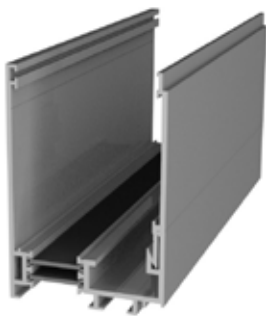

Anwendung

Alle Montagehinweise, Anwendungsvoraussetzungen und weitere technische Informationen entnehmen Sie bitte den technischen Handbüchern und den Montageanleitungen.



Germany

RODECA GmbH
Freiherr-vom-Stein-Straße 165
D-45473 Mülheim an der Ruhr
Fon +49 (0) 208 76502-0
Fax +49 (0) 208 76502-11
info@rodeca.de
www.rodeca.de

United Kingdom

RODECA Ltd.
Bentalls House
Bentalls
Pipps Hill Industrial Estate
Basildon
Essex SS14 3BS
Fon + 44 (0) 1268 531466
Fax + 44 (0) 1268 526351
sales@rodeca.co.uk
www.rodeca.co.uk

Italy

ANSA Termoplastici S.r.l./RODECA Italy
Concessionaria per l'Italia di RODECA GmbH
Via Nazionale, 66
24060 Sovere (BG)
Fon +39 035 981431
Fax +39 035 981529
info@rodeca.it
www.rodeca.it

The Netherlands

RODECA Systems b.v.
Koperweg 11 N
2401 LH Alphen aan den Rijn
Fon +31 (0) 172 416 747
Fax +31 (0) 172 419 090
info@rodeca.nl
www.rodeca.nl

Belgium and Luxembourg

RODECA Systems BELUX bvba
Wupstraat 37
2812 Muizen/Mechelen
Mobile +32 (0) 468 137 677
Fax (NL) +31 (0) 172 419 090 (RODECA Systems b.v.)
info@rodeca.be
www.rodeca.be

South America

REPLAEX RESINAS PLÁSTICAS EXTRUDADAS LTDA
Autorizado America do Sul de RODECA GmbH
Estrada da Ligação, 839 - Taquara - Rio de Janeiro
RJ - BRASIL cep. 22713-470
Fon : +55 (0) 21 2446-8811
Fax : +55 (0) 21 2446-7181
vendas@replaex.com.br
www.replaex.com.br

Die RODECA Produktgruppen im Überblick / The RODECA product groups overview:



Lichtbauelemente

Translucent Building Elements



Hohlkammerscheiben

Multi Wall Sheets



Multi-Funktions-Paneele

Multi Function Panels



U-Paneele

U-Panels



RT-Thermolight

RT-Thermolight



Fenster

Windows



Do it yourself

Do it yourself