

Konstruktionsprofile 25 mm

M 1:2

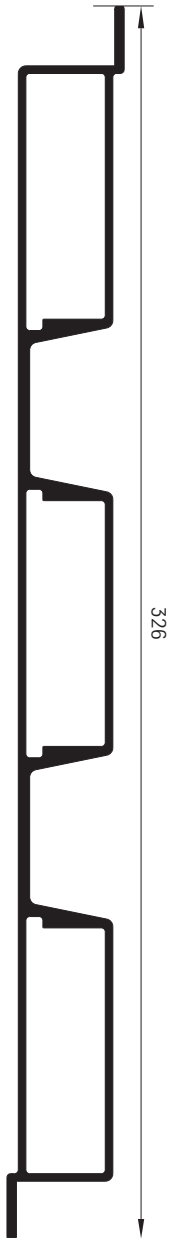

25116
Lüftungs-
klappenprofil

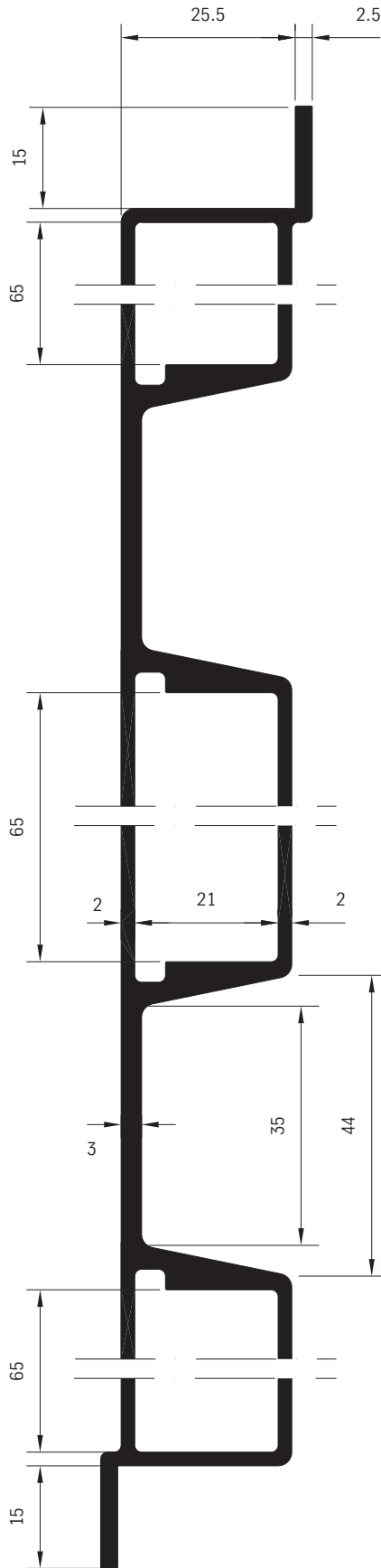

25116
4,50 kg/m

Scharnierprofil mit Gummidichtung
und Edelstahl-Achse
für Bordwände und Türen

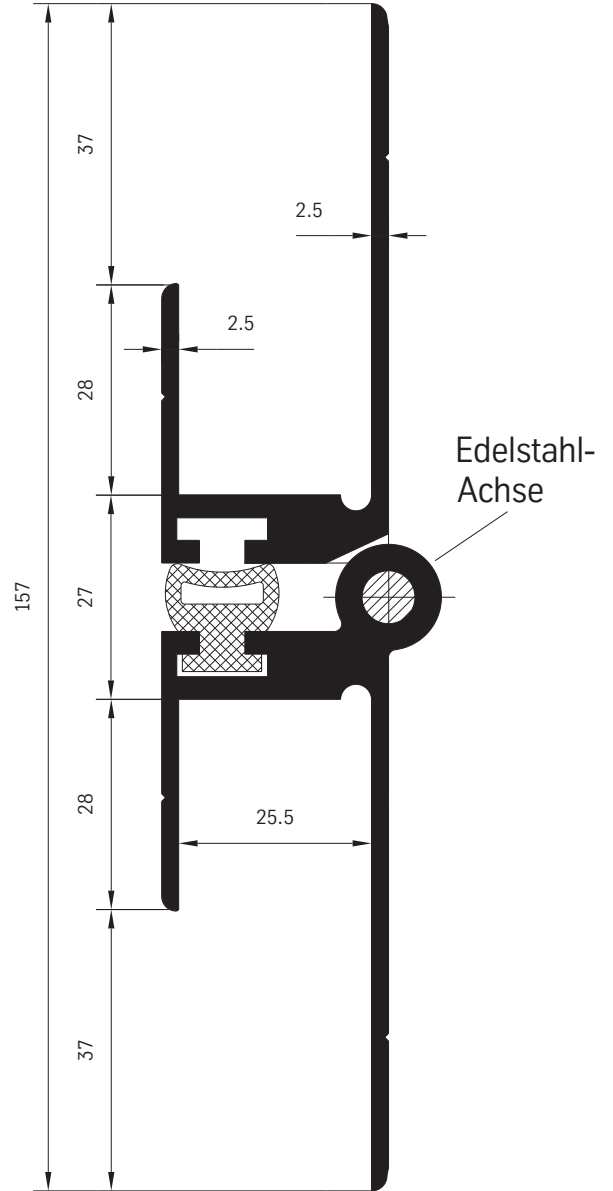

63584
Scharnier komplett 25 mm

Konstruktionsprofile 25 mm

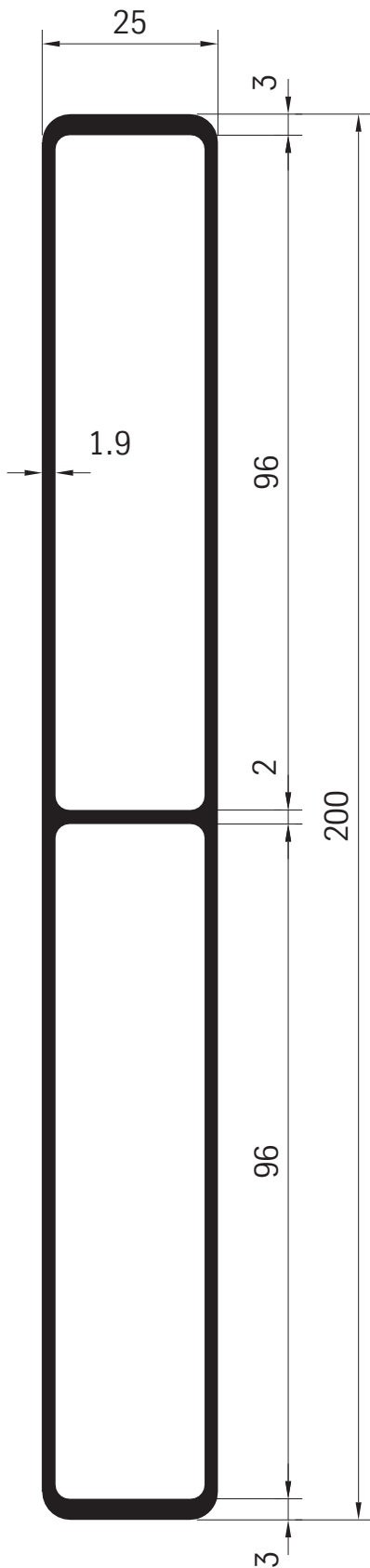

25121
2,49 kg/m

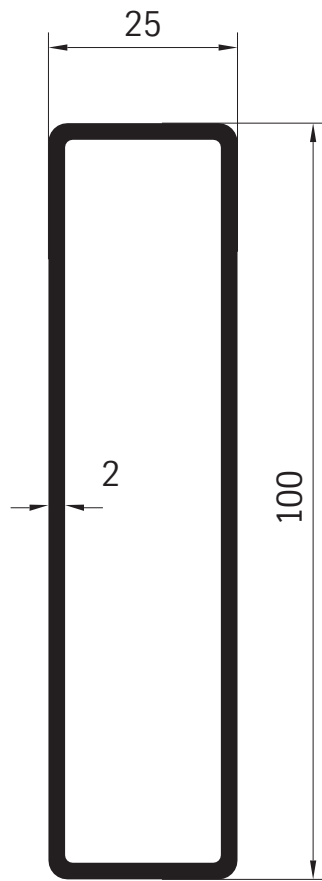

25020
1,42 kg/m

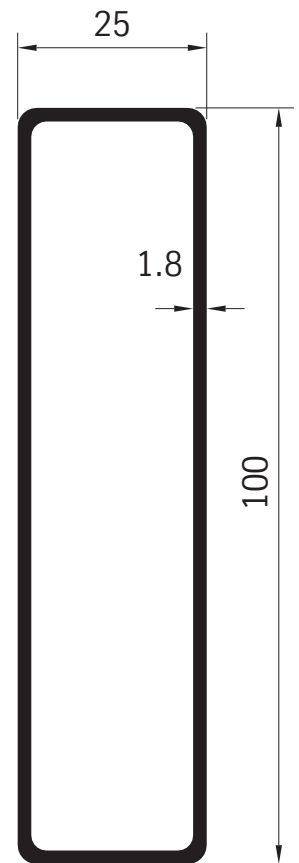

25021
1,17 kg/m

Pritschenaufbau-Profile System Palcom

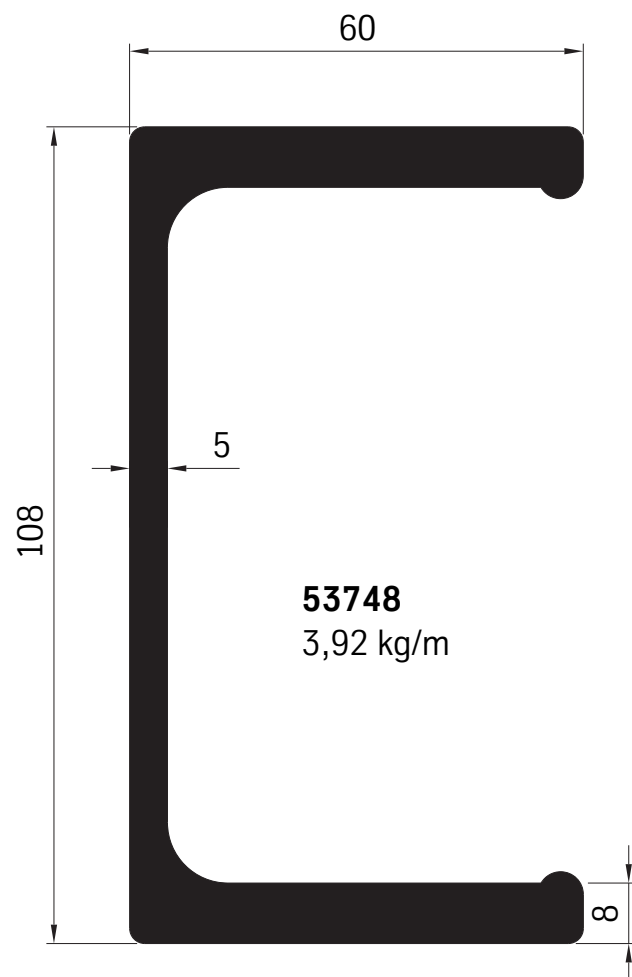
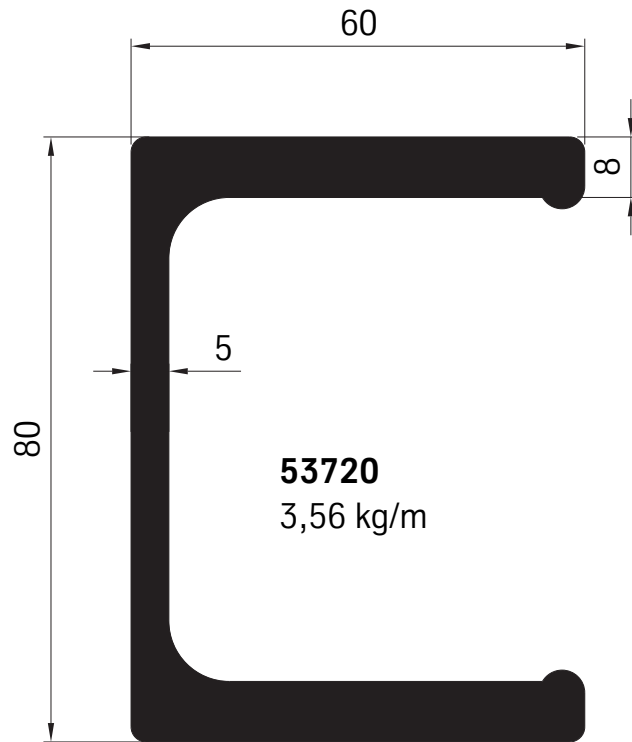

Pritschenaufbau-Profile

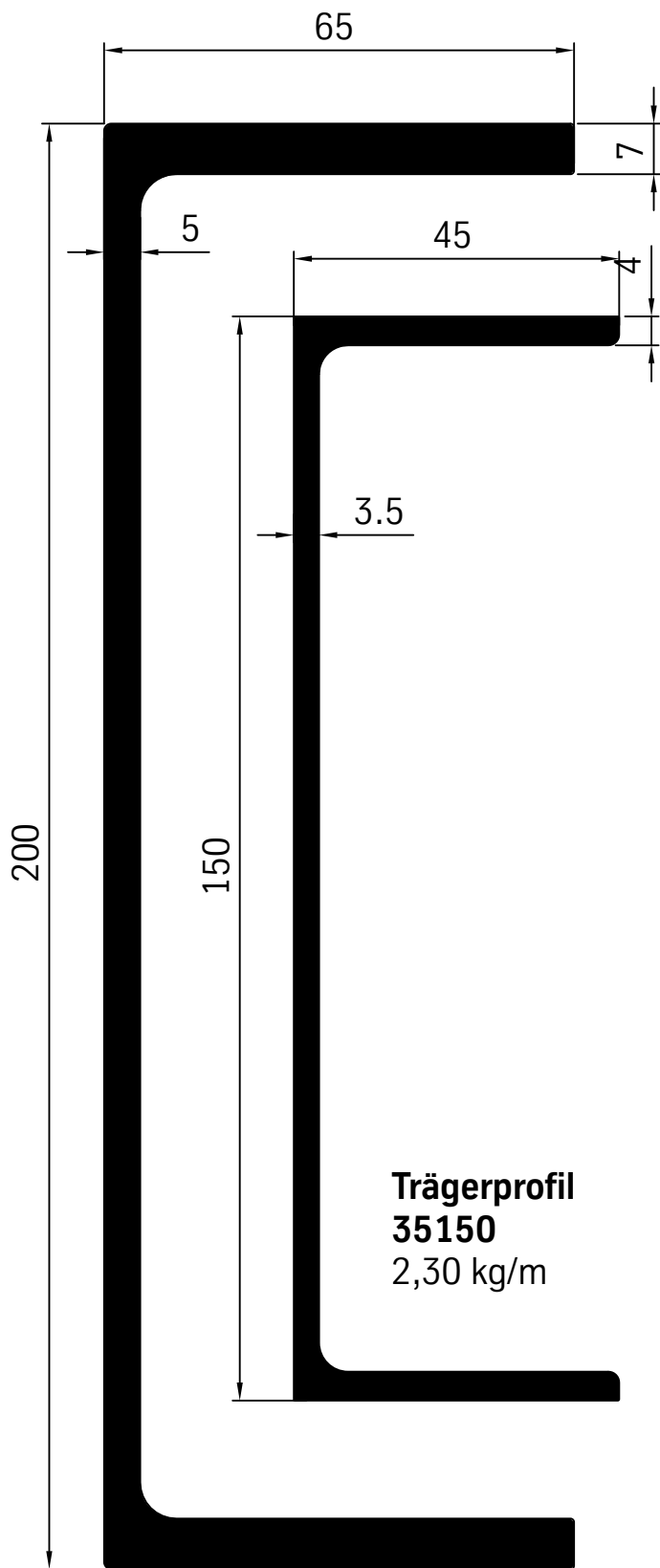

**Trägerprofil
40200**
4,97 kg/m

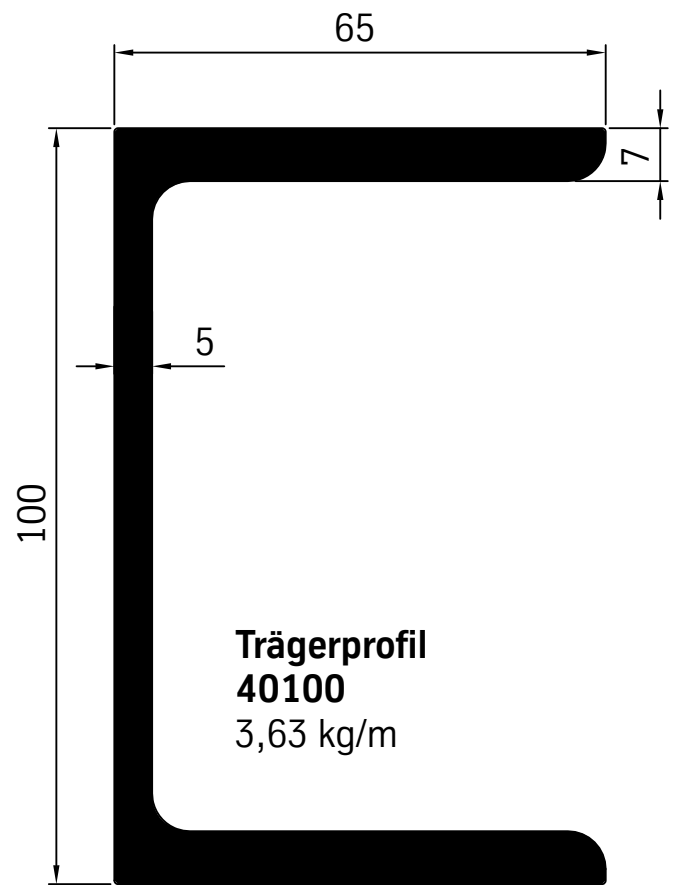

**Trägerprofil
40100**
3,63 kg/m

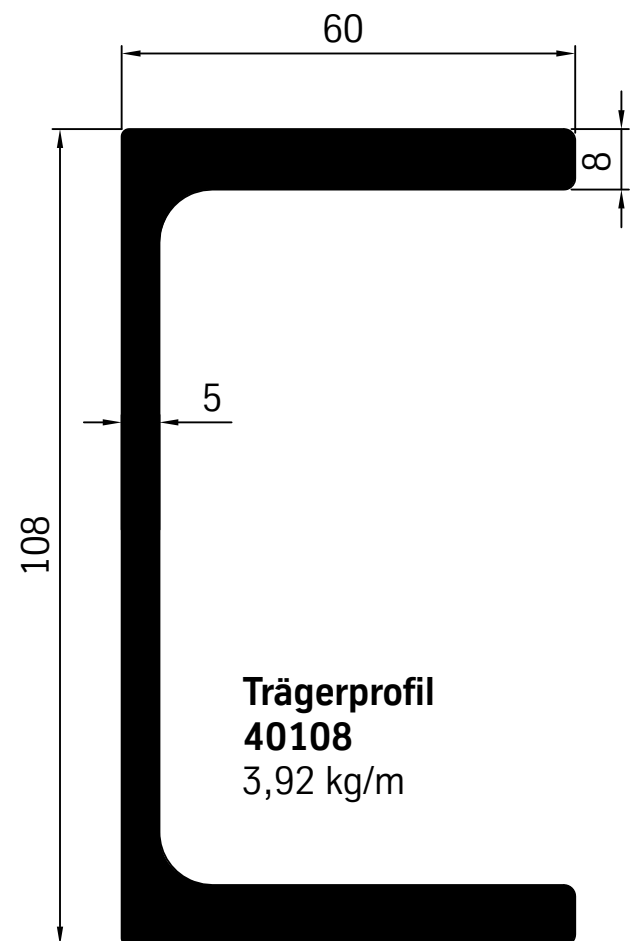

**Trägerprofil
40108**
3,92 kg/m

Pritschenaufbau-Profile

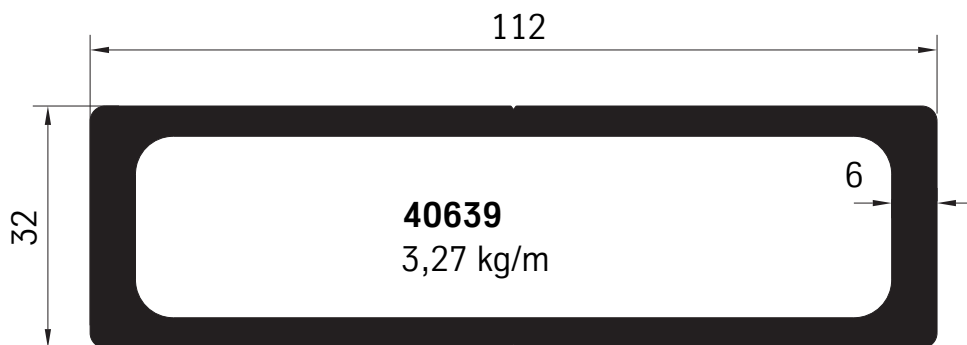
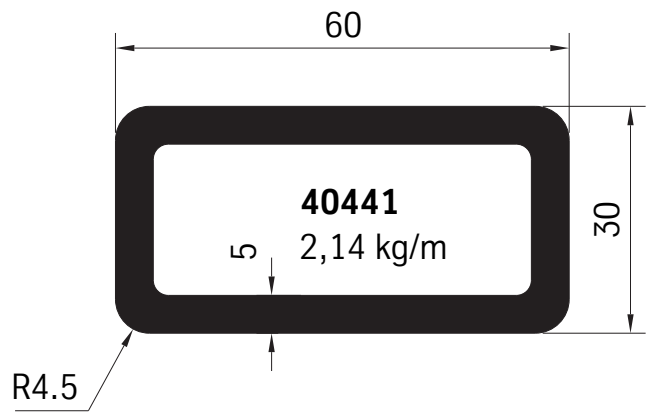
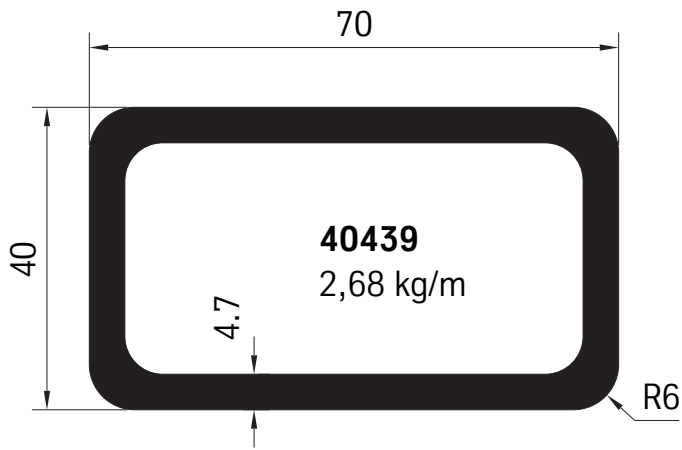
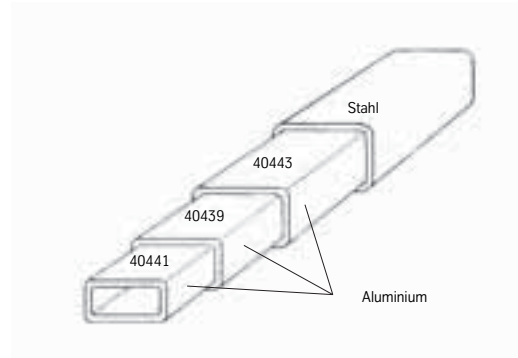
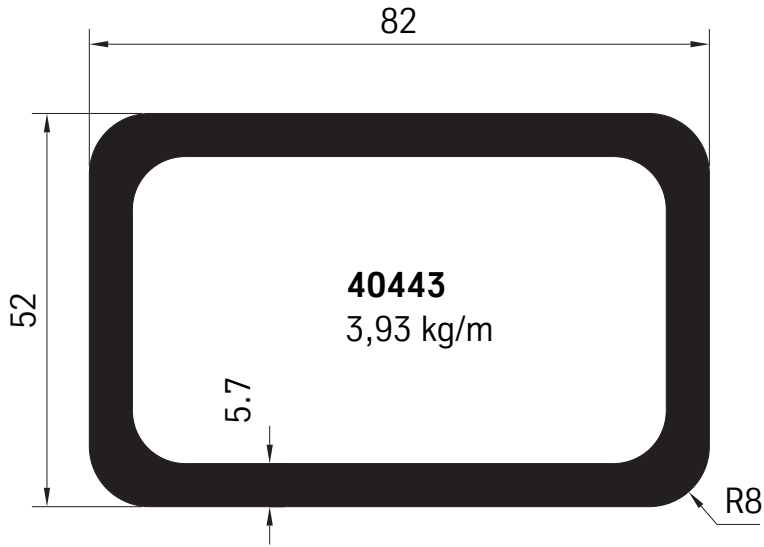

Mulden-System-Profile

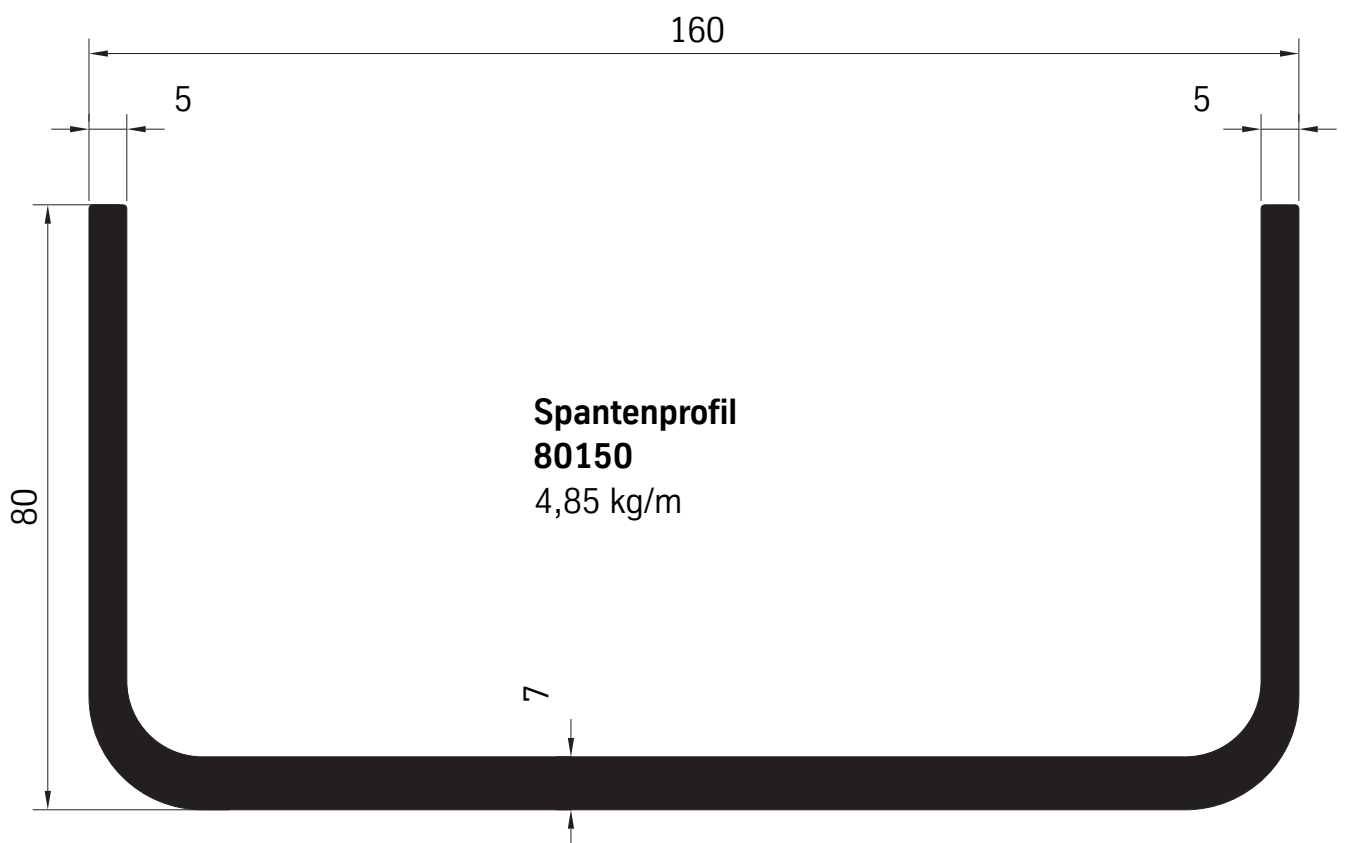
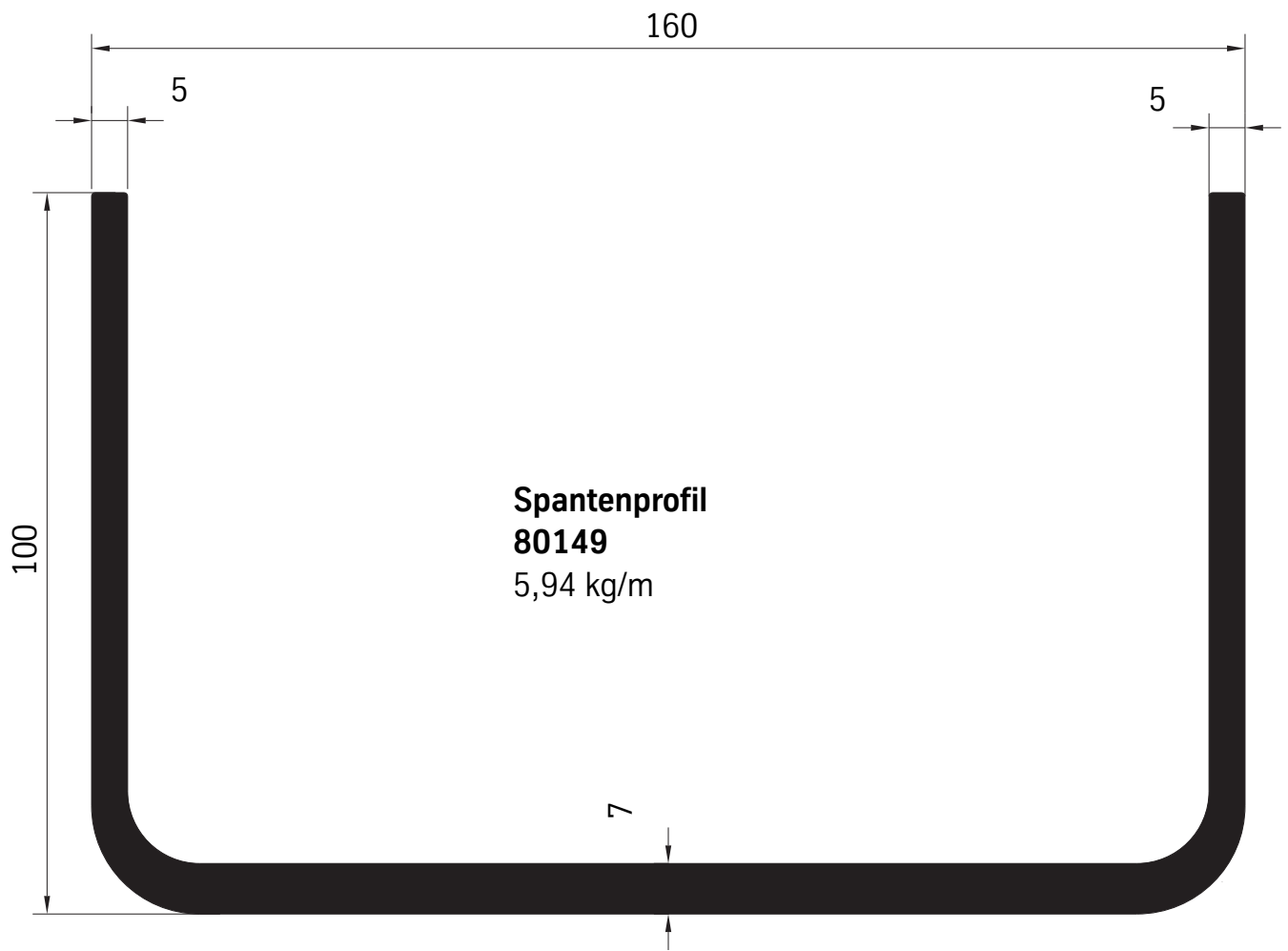

Mulden-System-Profile

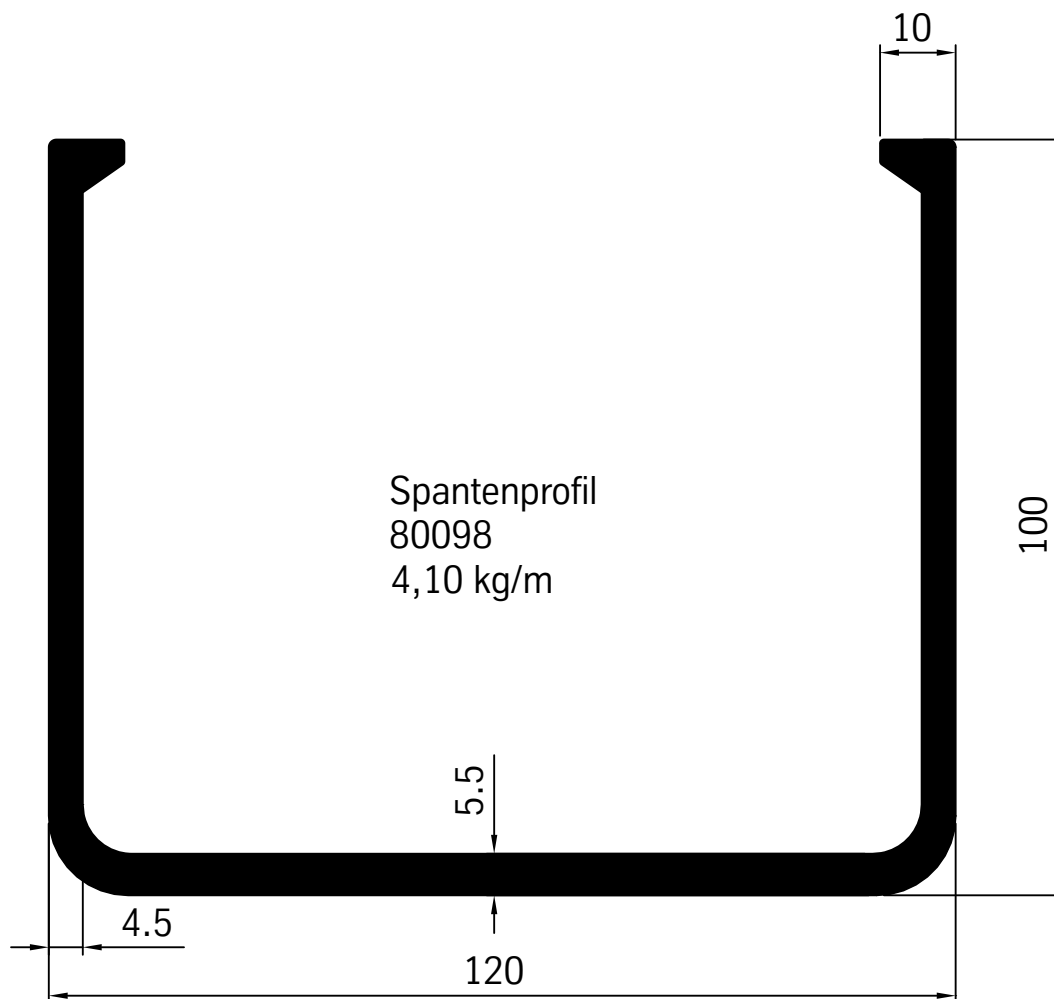
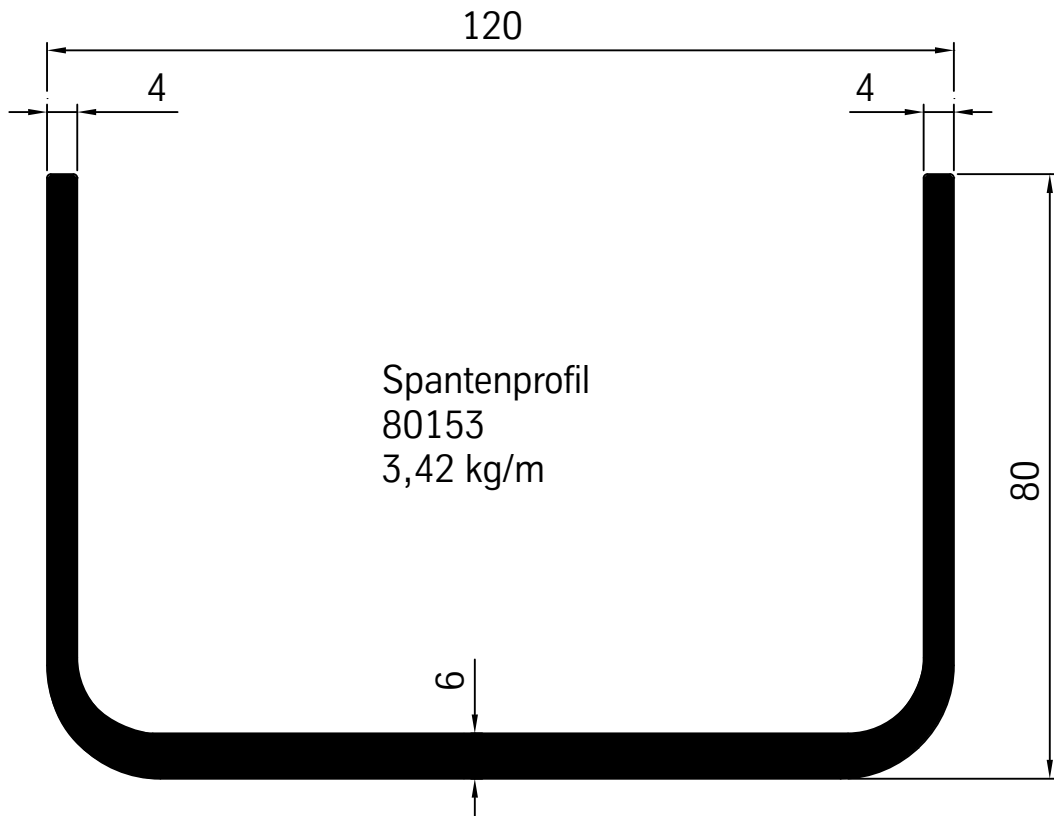

Mulden-System-Profile

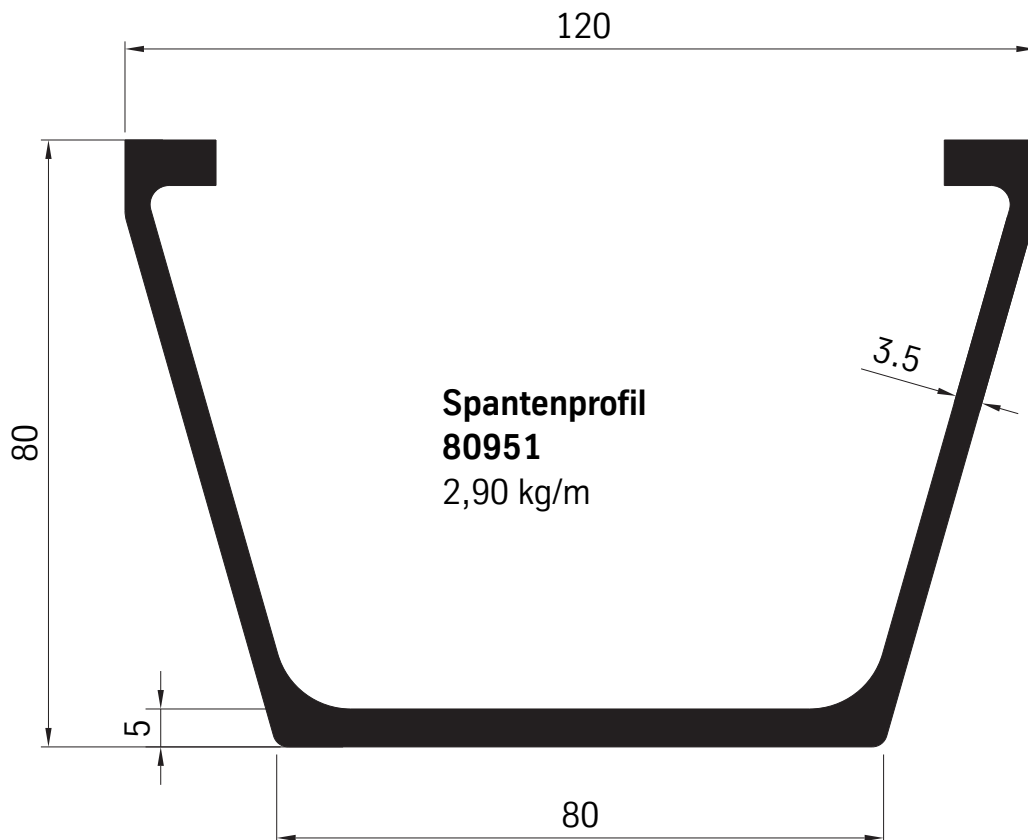
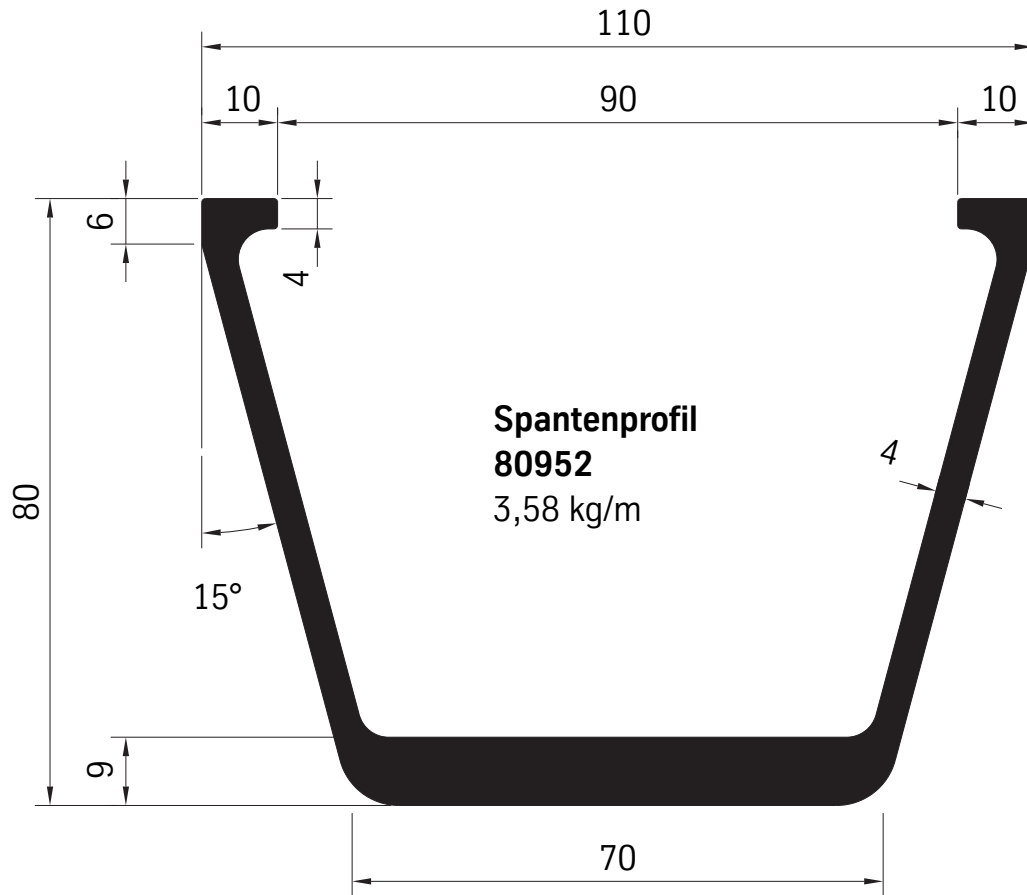

Mulden-System-Profile

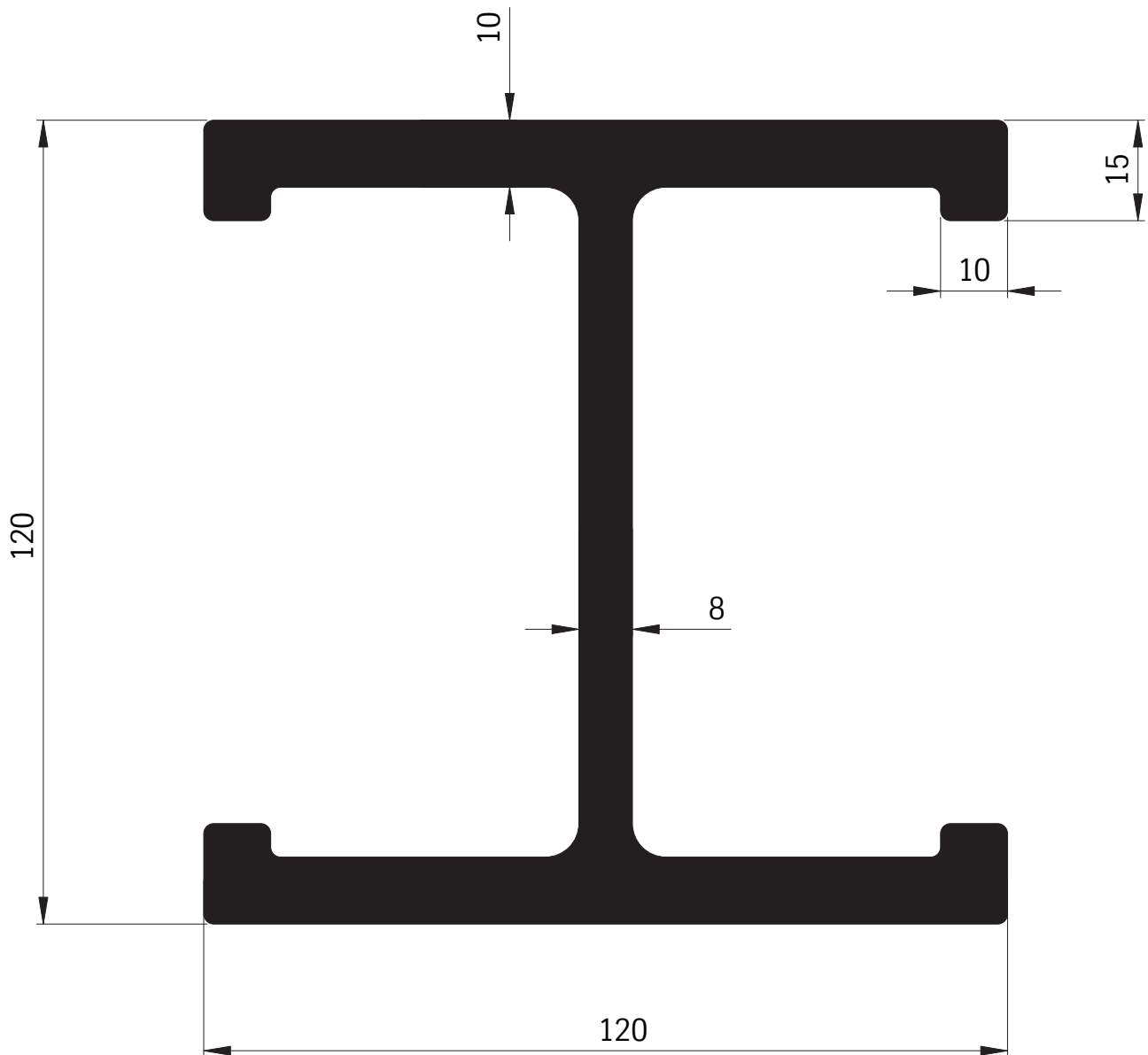

Querträgerprofil

80120

9,40 kg/m

Mulden-System-Profile

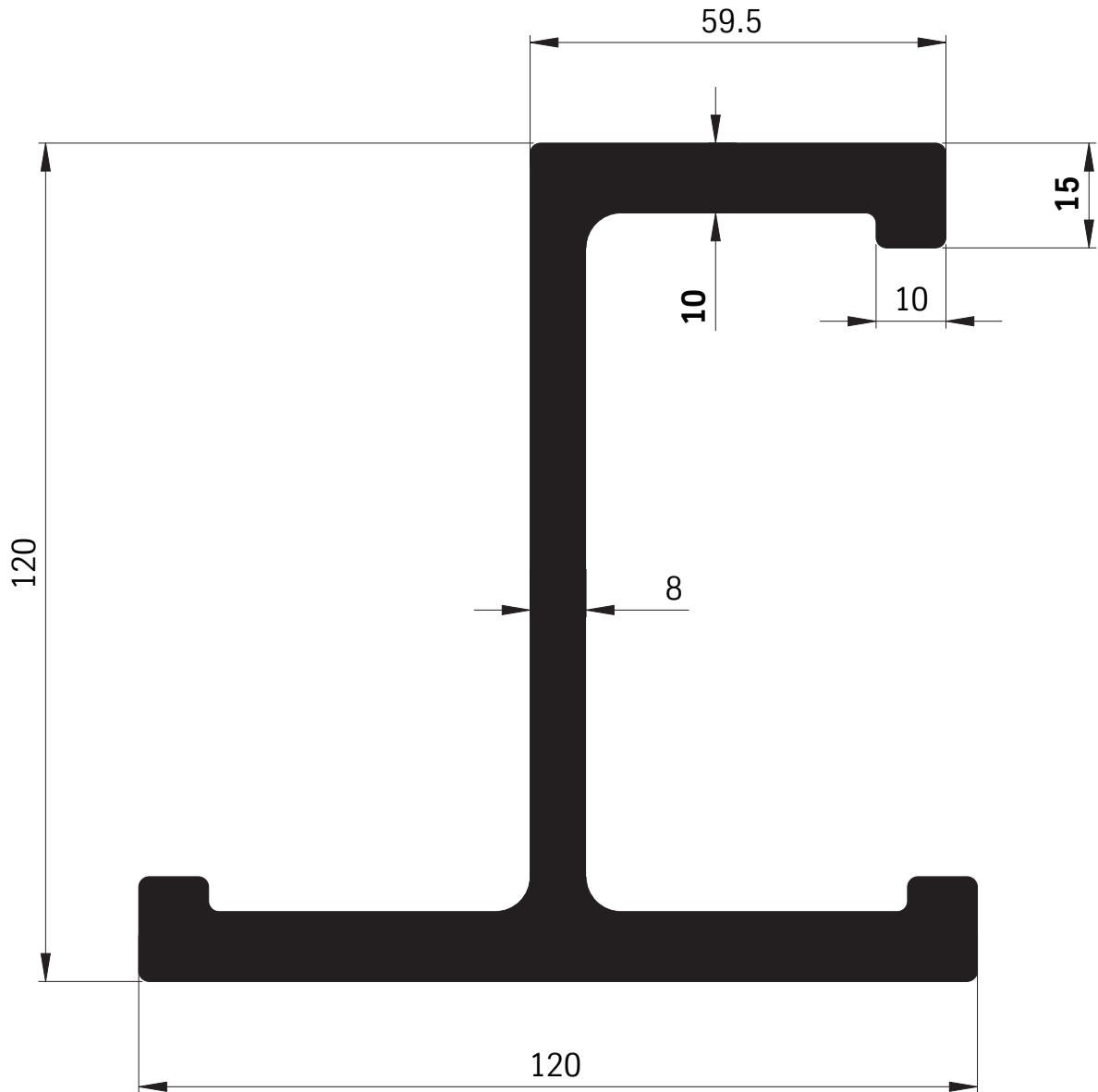

Querträgerprofil

80121

7,60 kg/m

Mulden-System-Profile

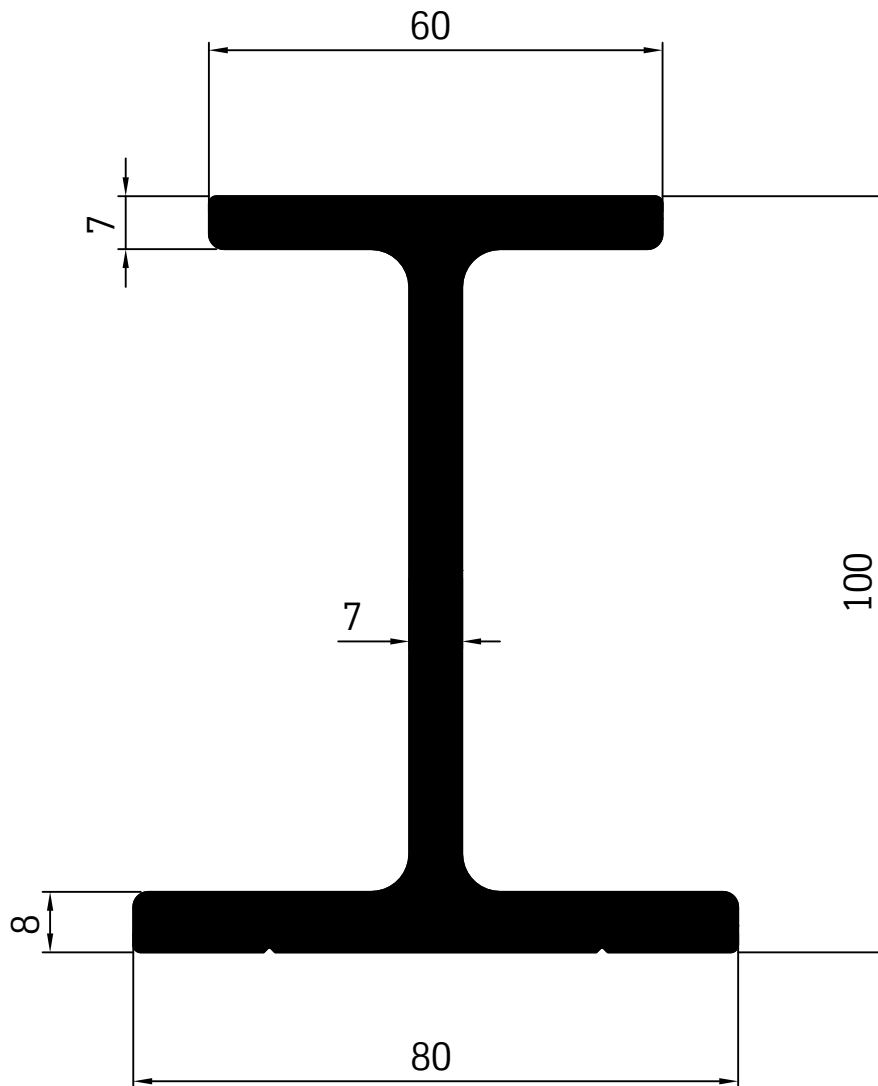

Querträgerprofil
80122
4,65 kg/m

Mulden-System-Profile

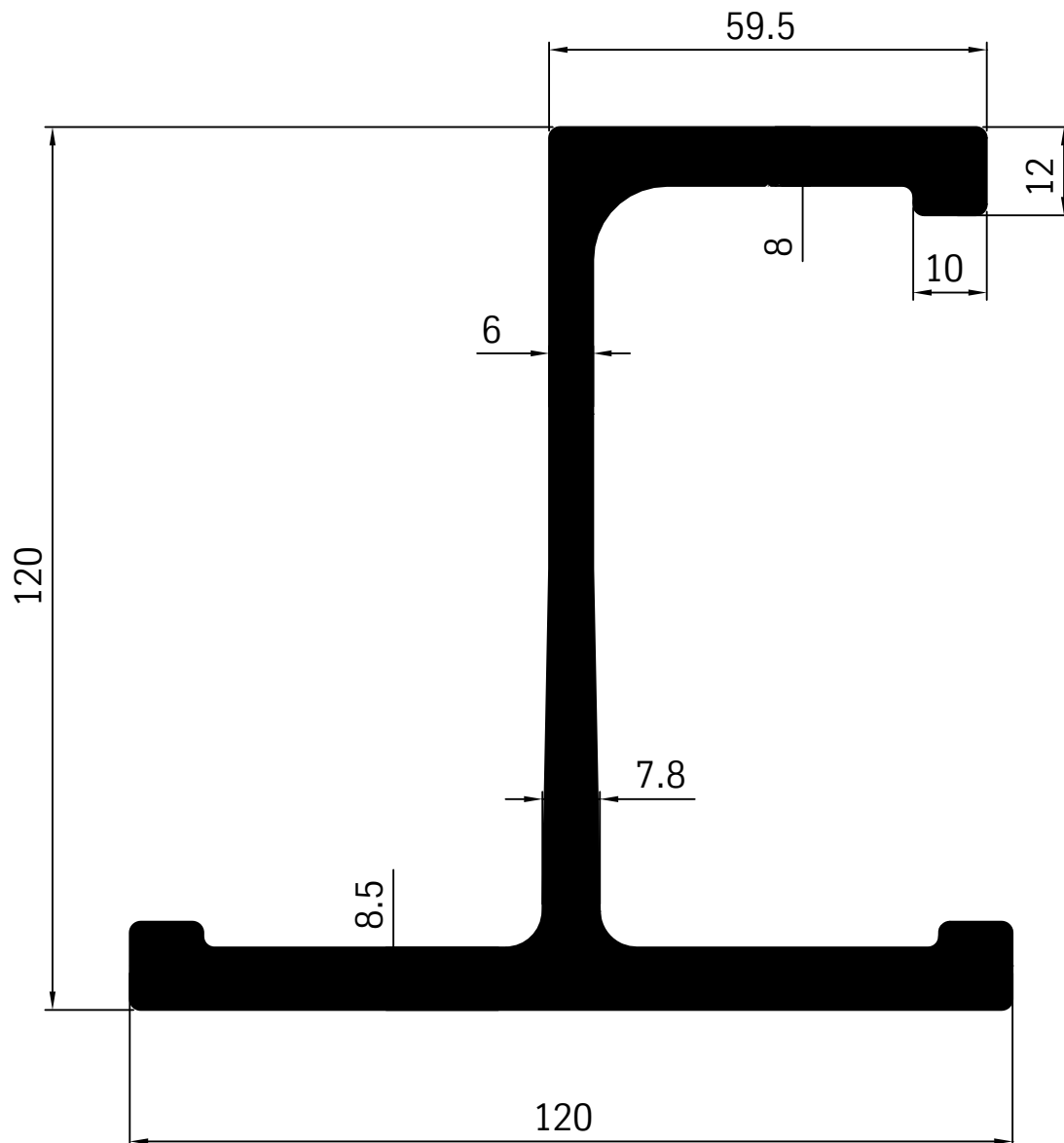

Querträgerprofil
80123
6,30 kg/m

Mulden-System-Profile

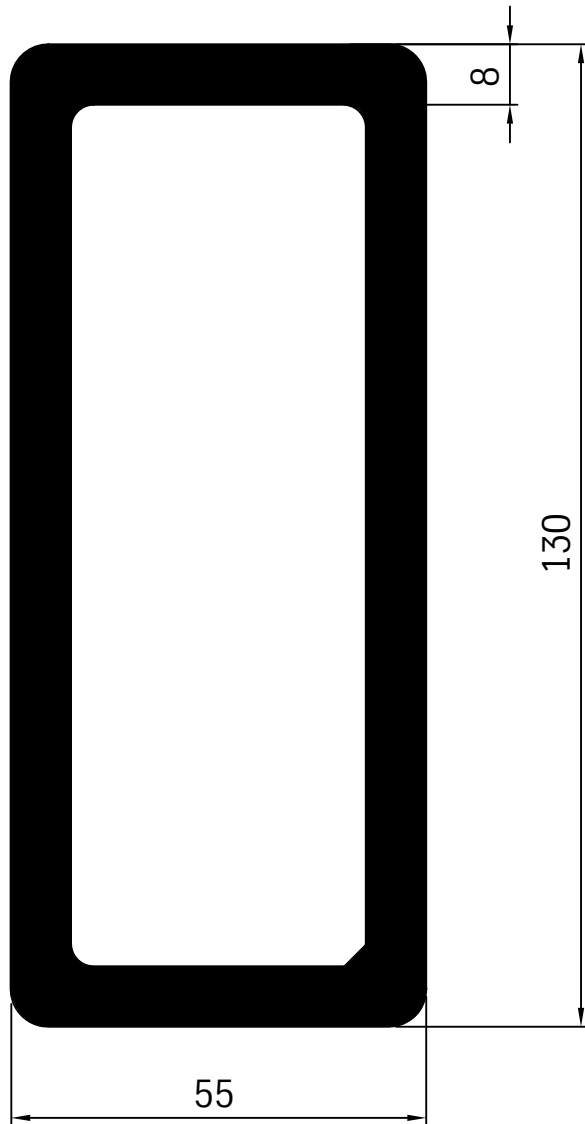

Vierkantrohr
80734
7,30 kg/m

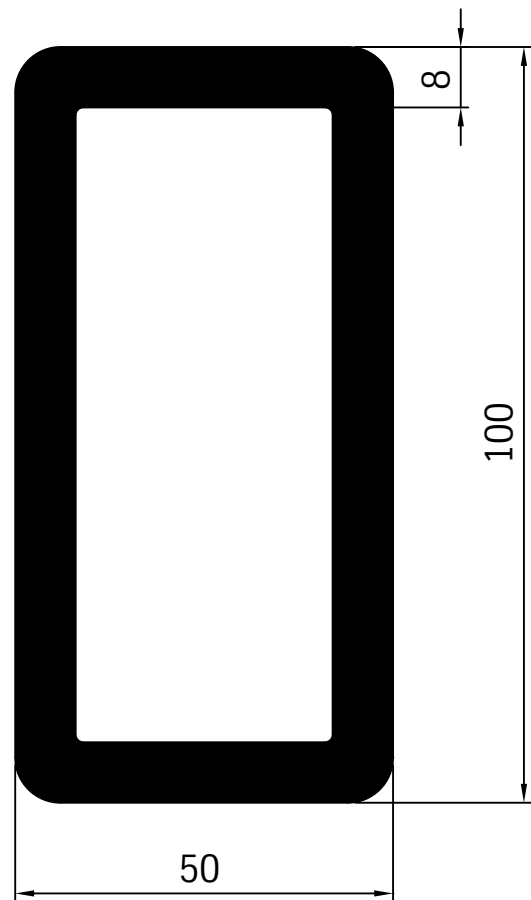

Vierkantrohr
80148
5,72 kg/m

Mulden-System-Profile

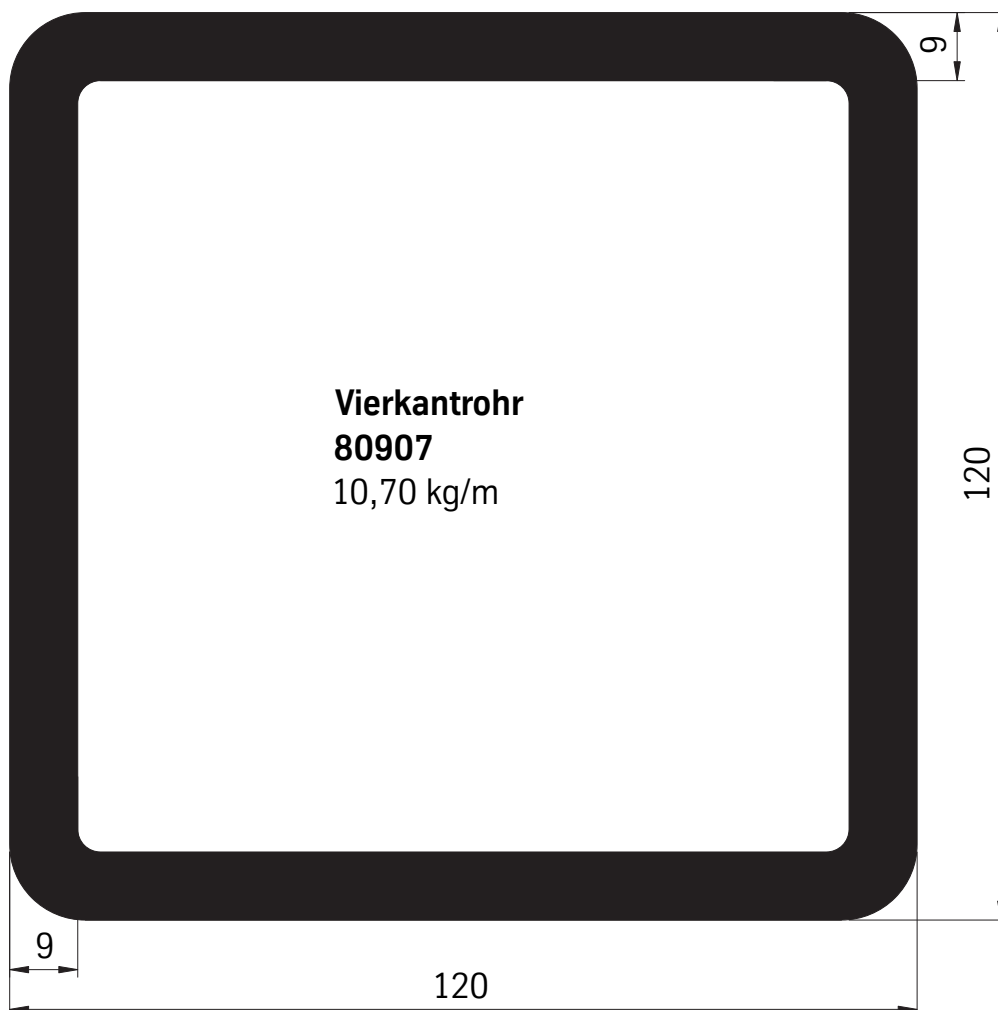
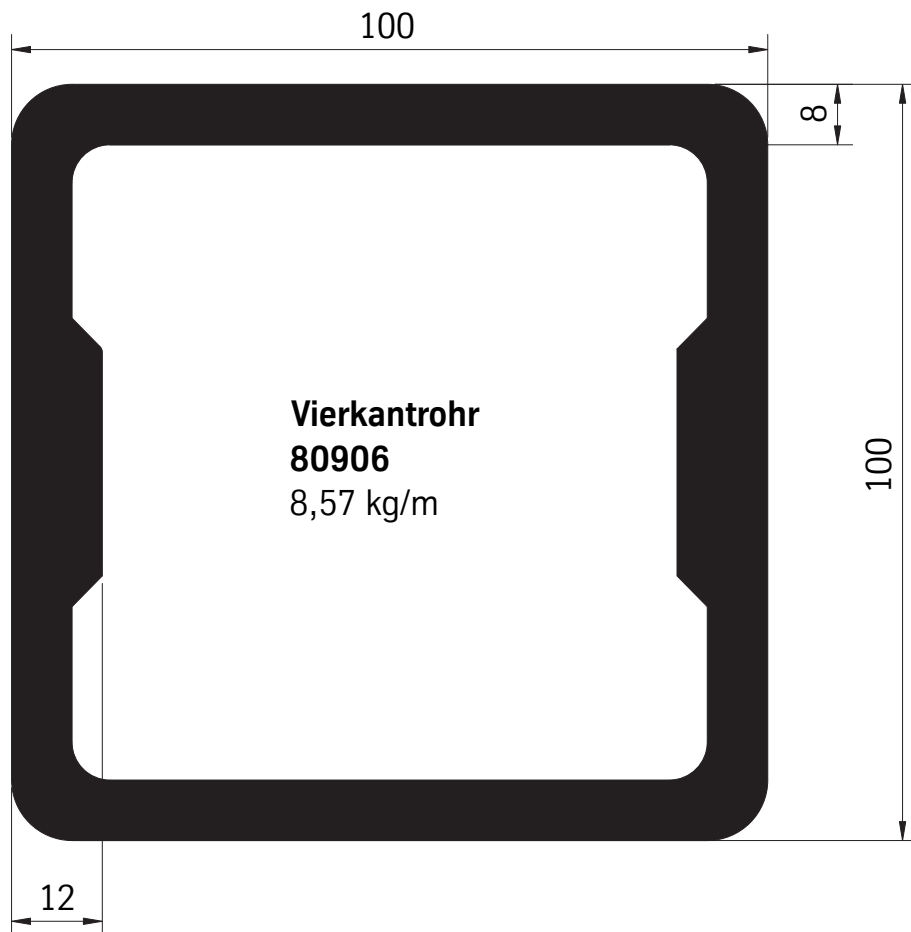

Mulden-System-Profile

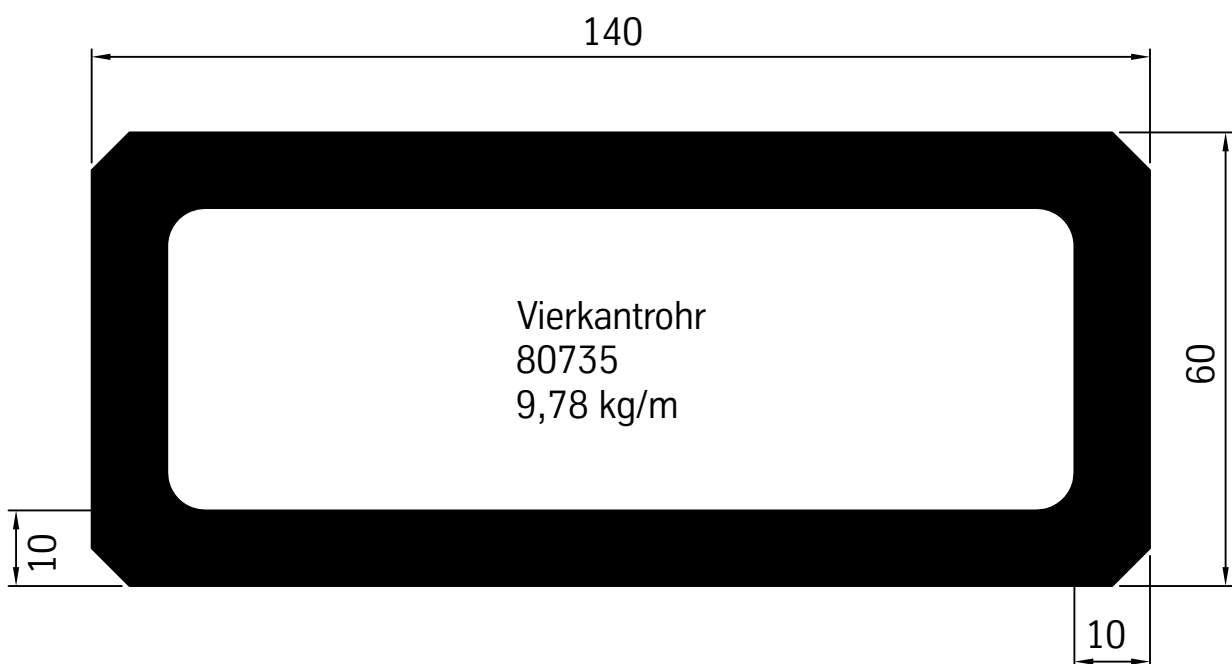
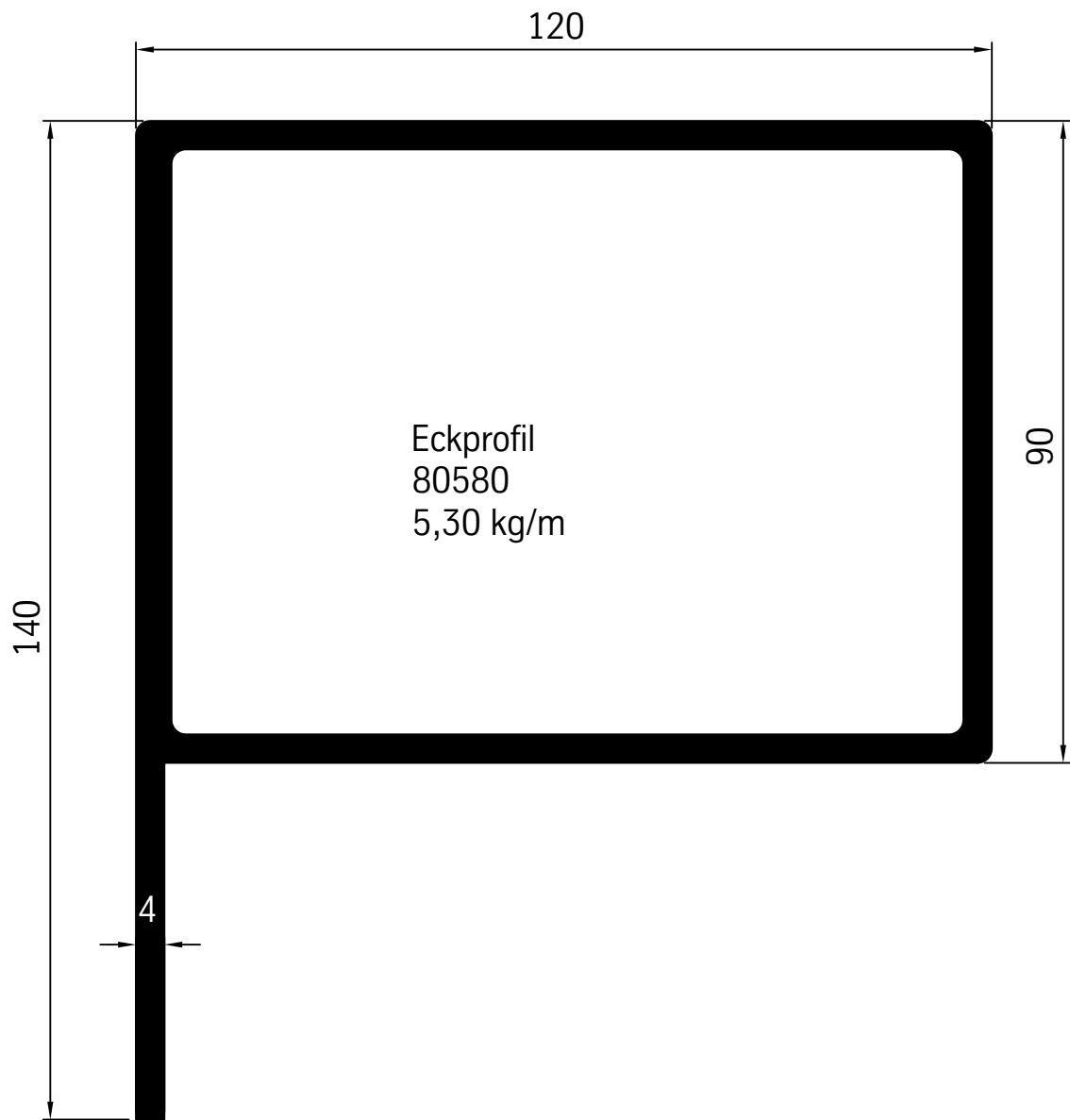

Fahrgestell-System-Profile

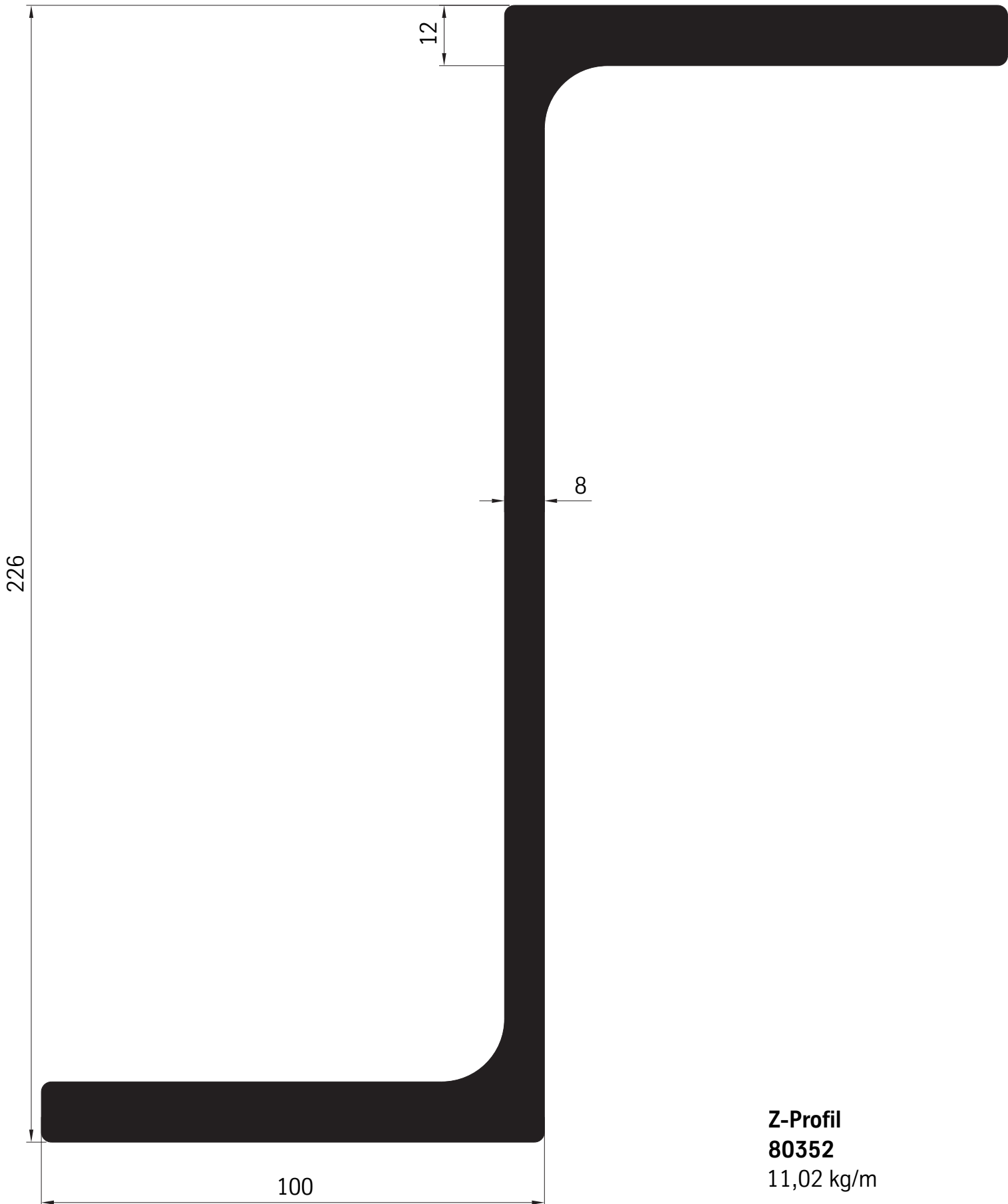

Z-Profil
80352
11,02 kg/m

Fahrgestell-System-Profile

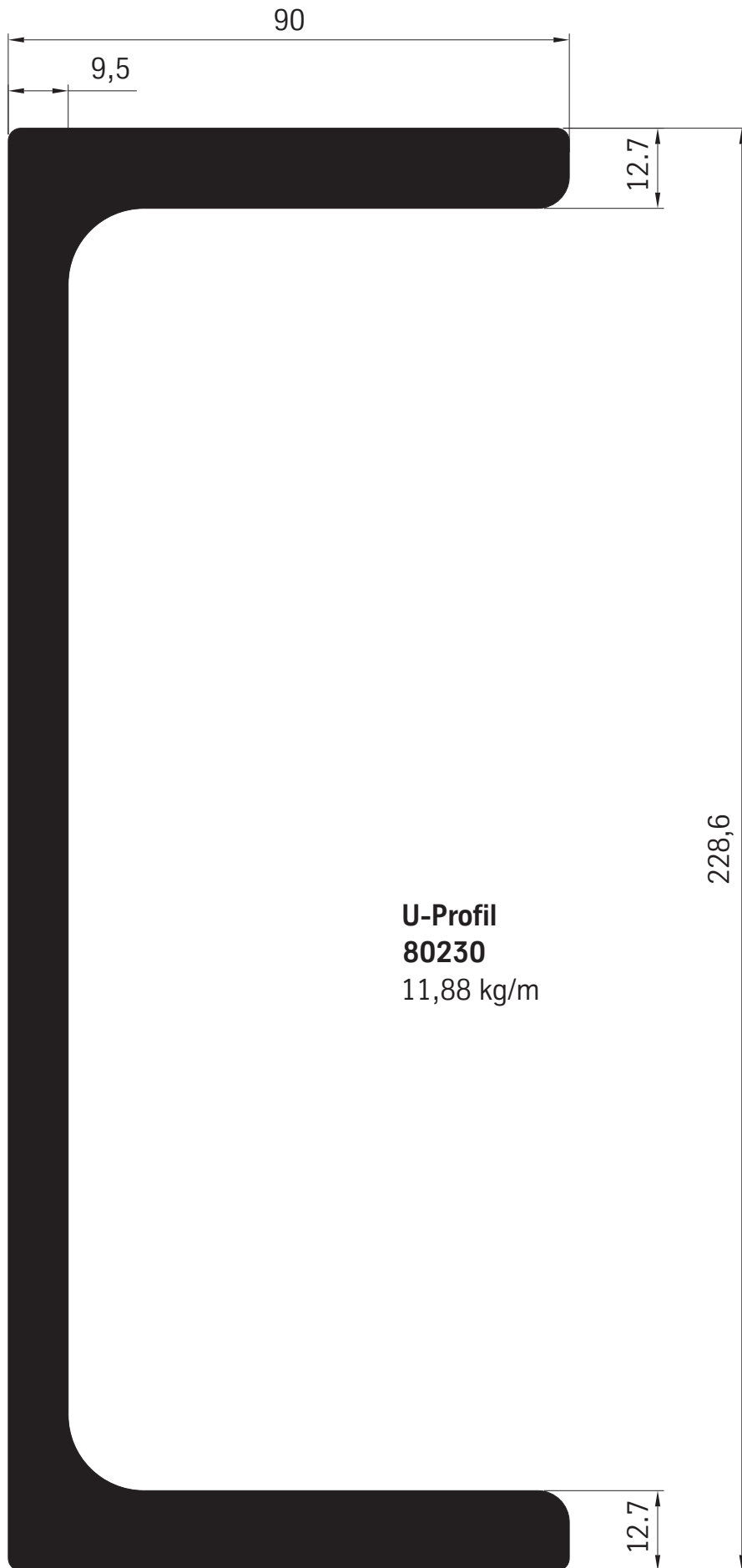

U-Profil
80230
11,88 kg/m

Fahrgestell-System-Profile

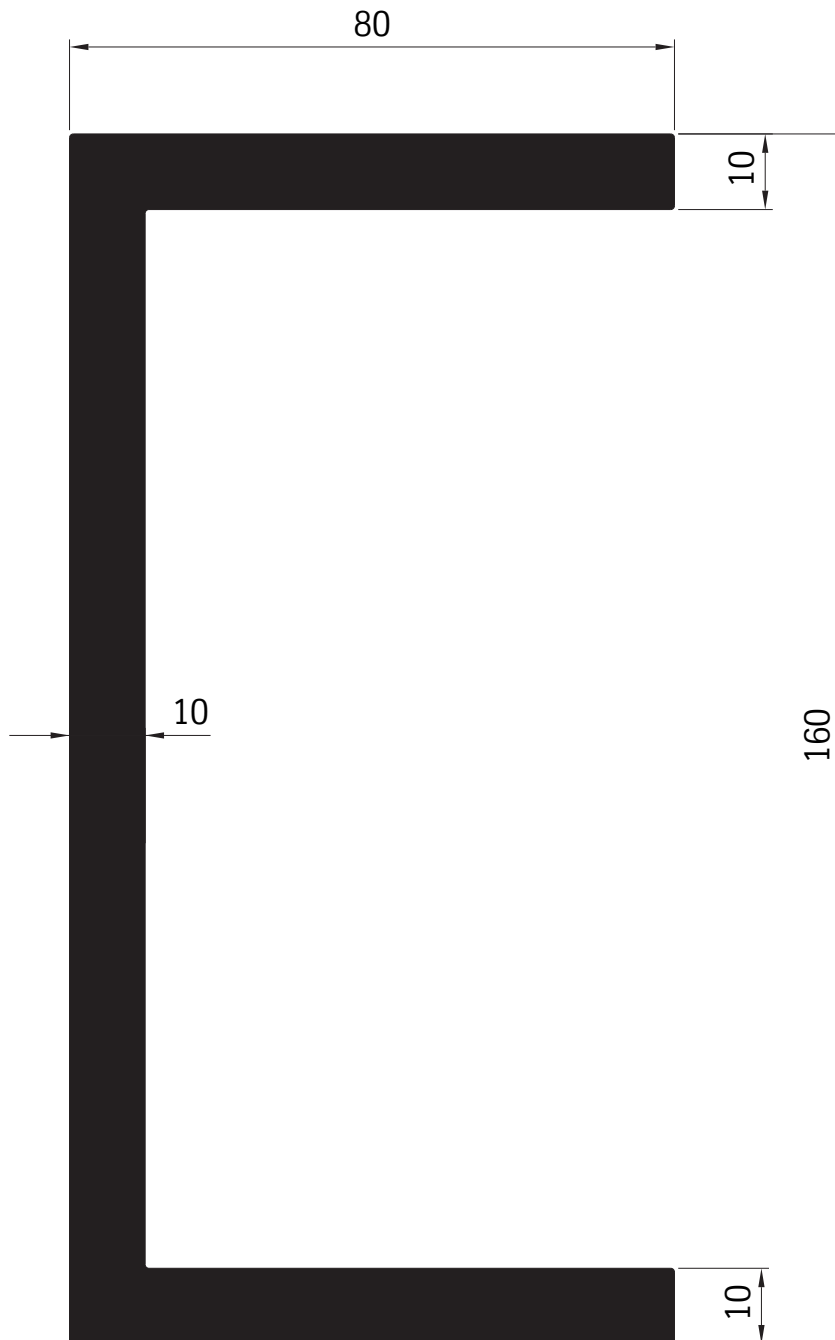

U-Profil
80160
8,20 kg/m

Fahrgestell-System-Profile

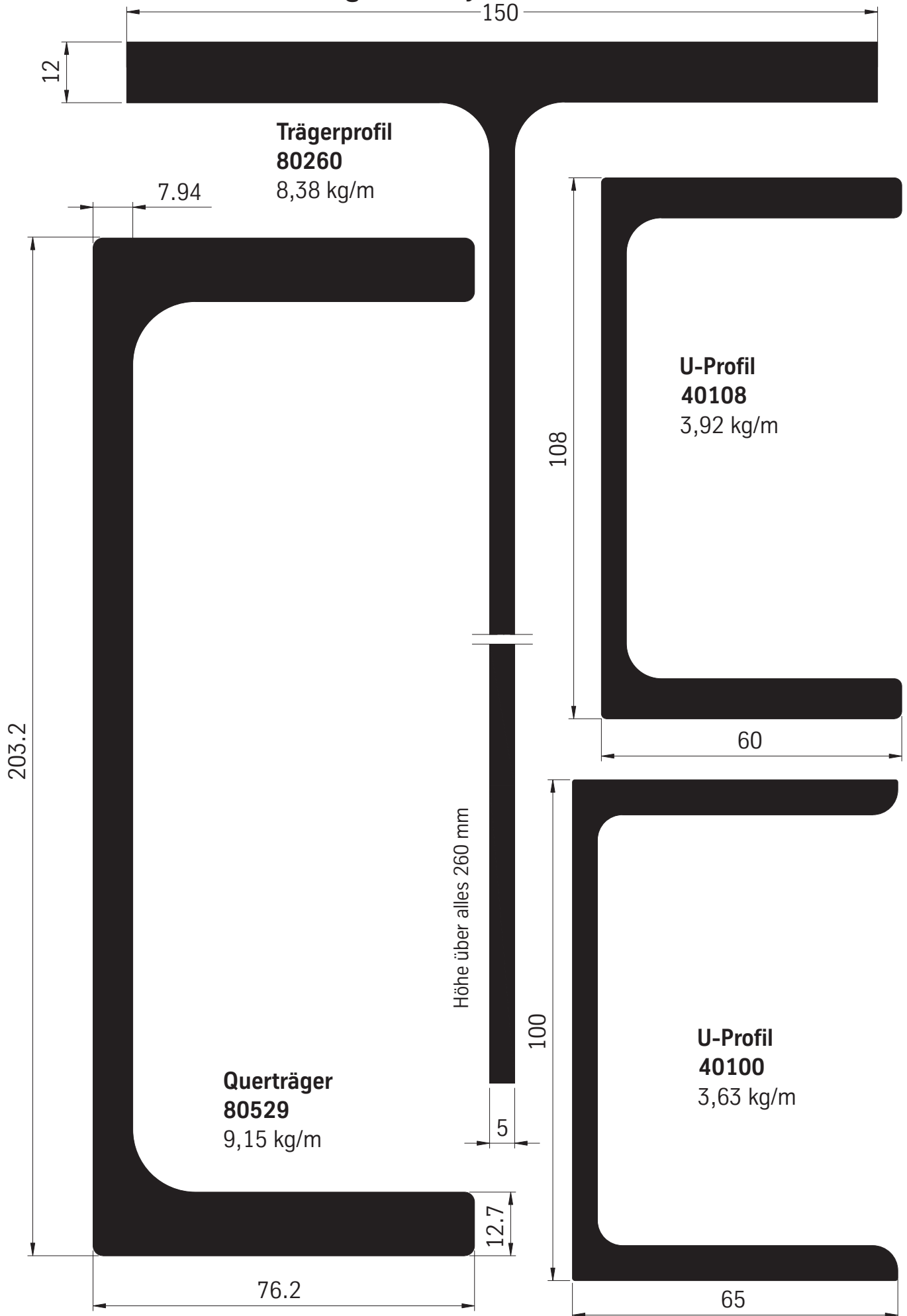

Fahrgestell-System-Profile

