

Mulden-System 50 mm

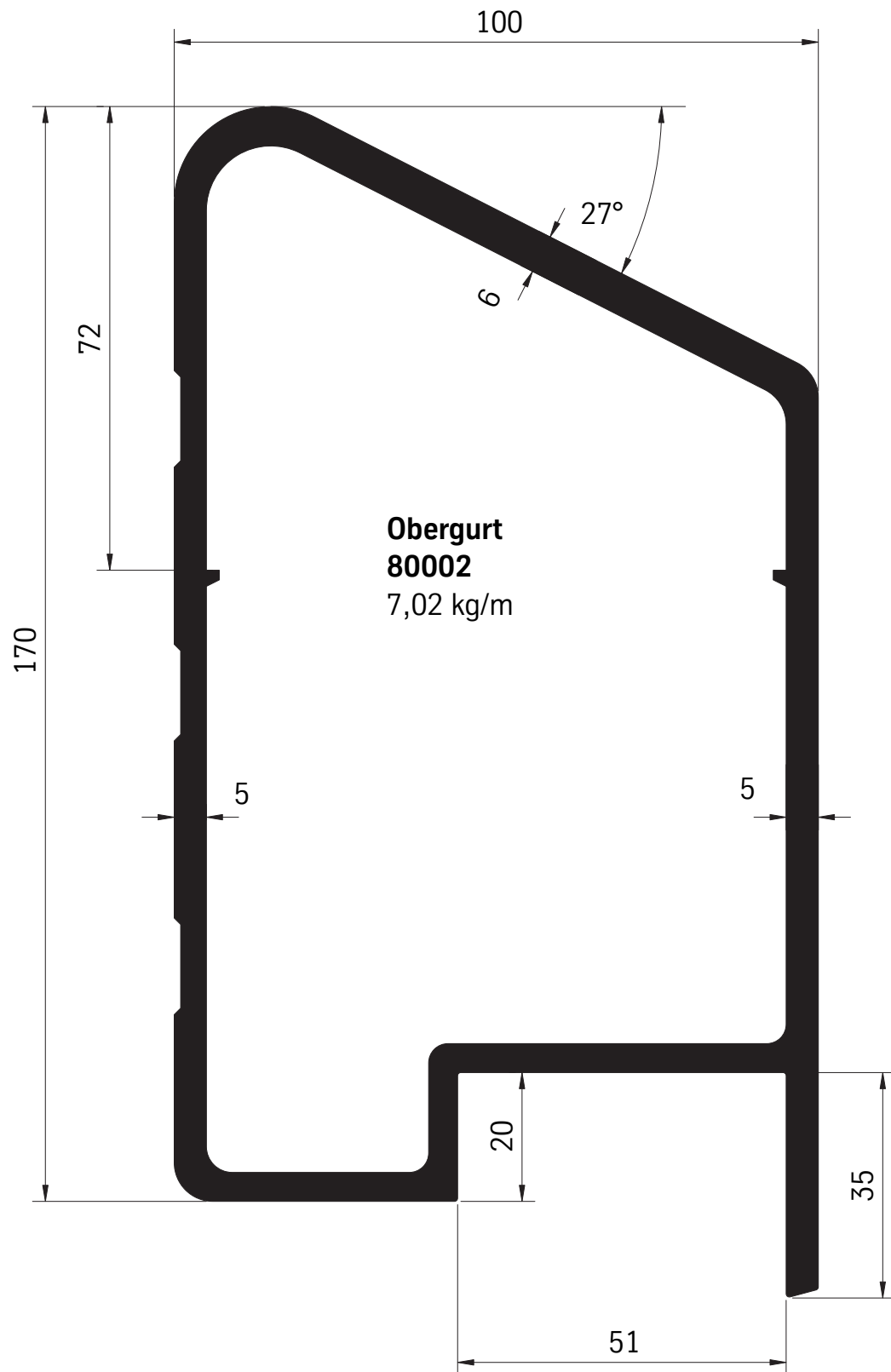

Mulden-System 50 mm

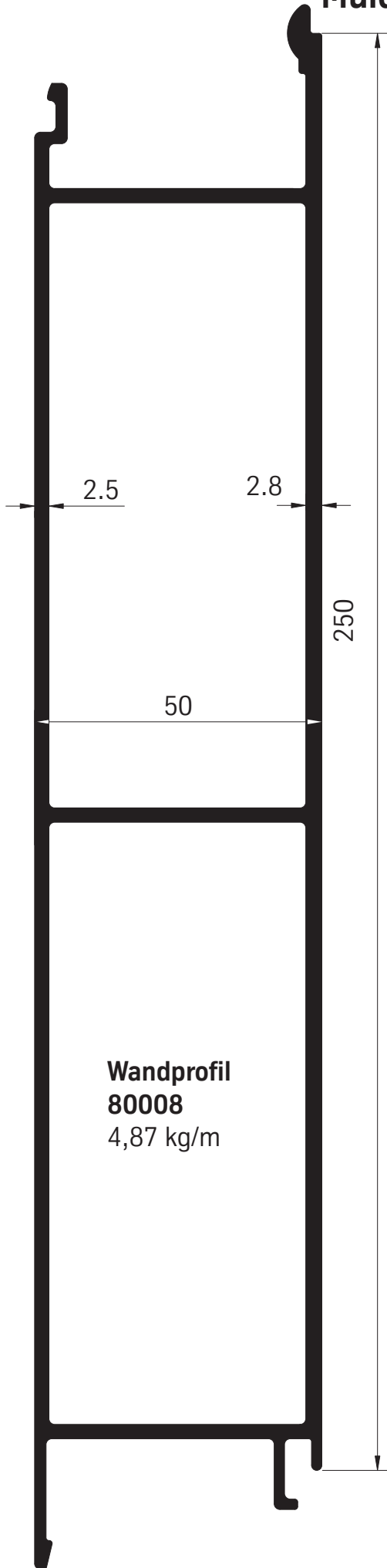

**Wandprofil
80008**
4,87 kg/m

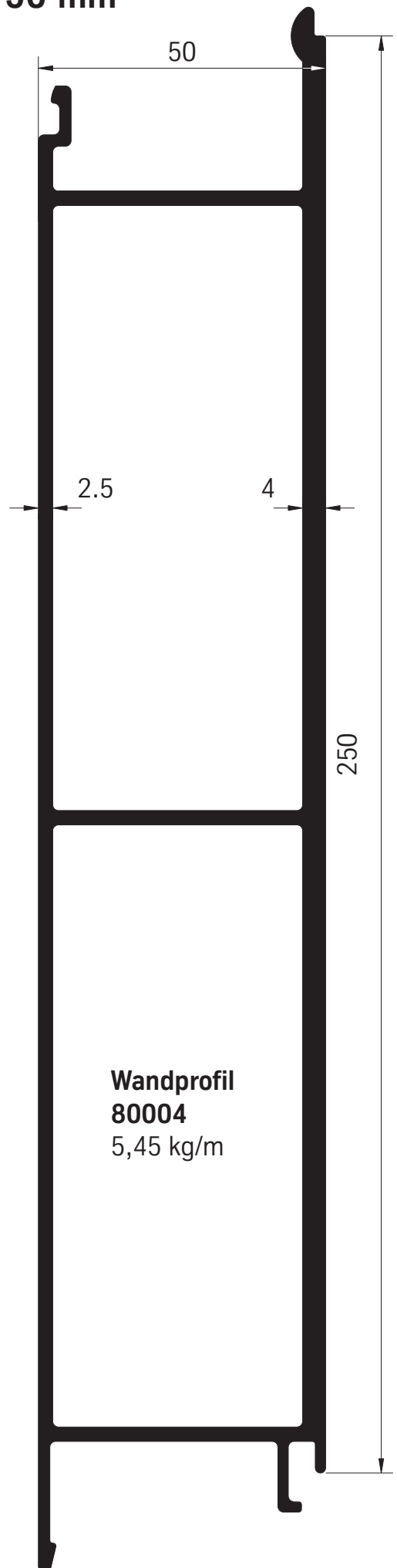

**Wandprofil
80004**
5,45 kg/m

Mulden-System 50 mm

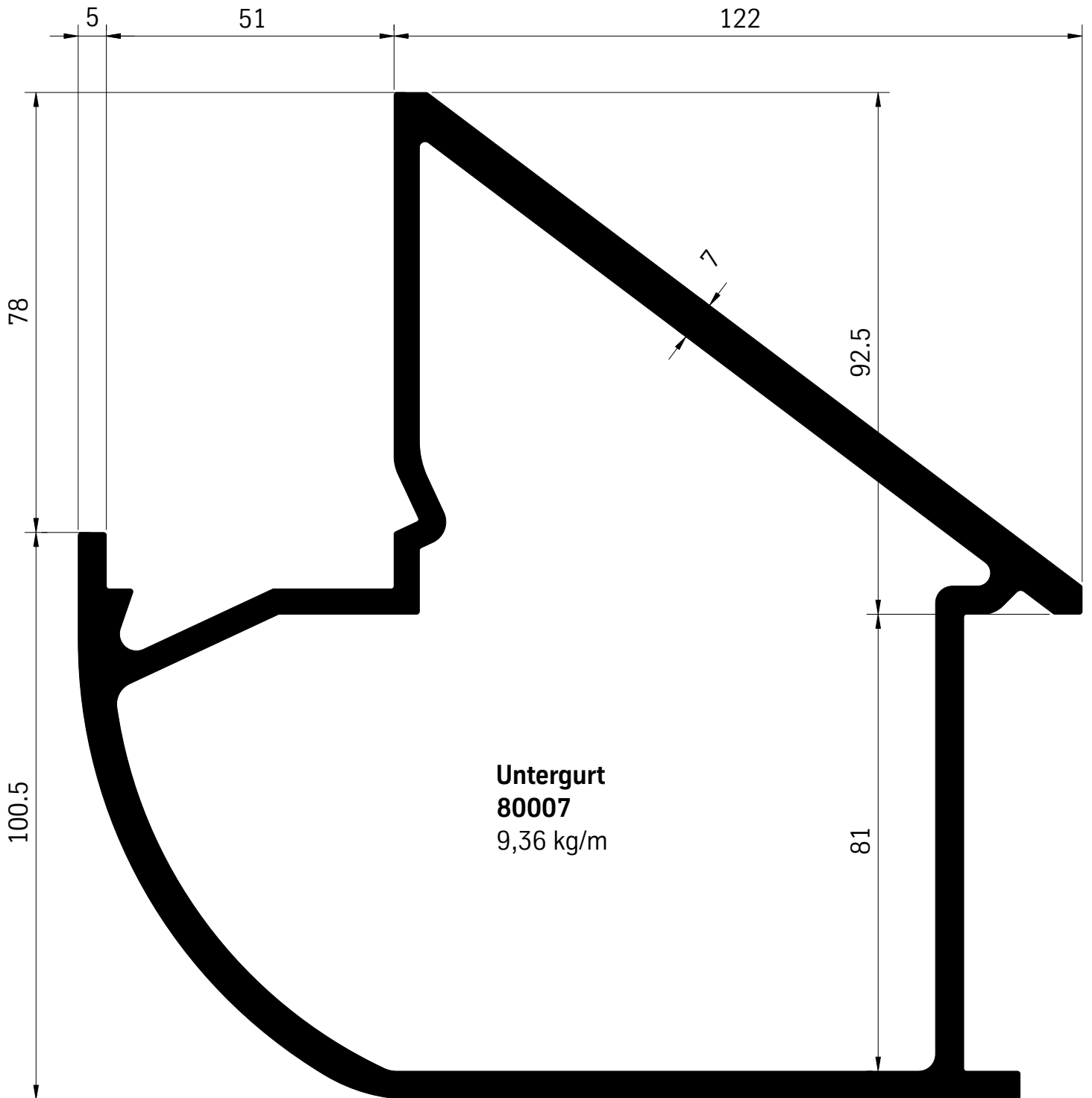

Mulden-System 50 mm

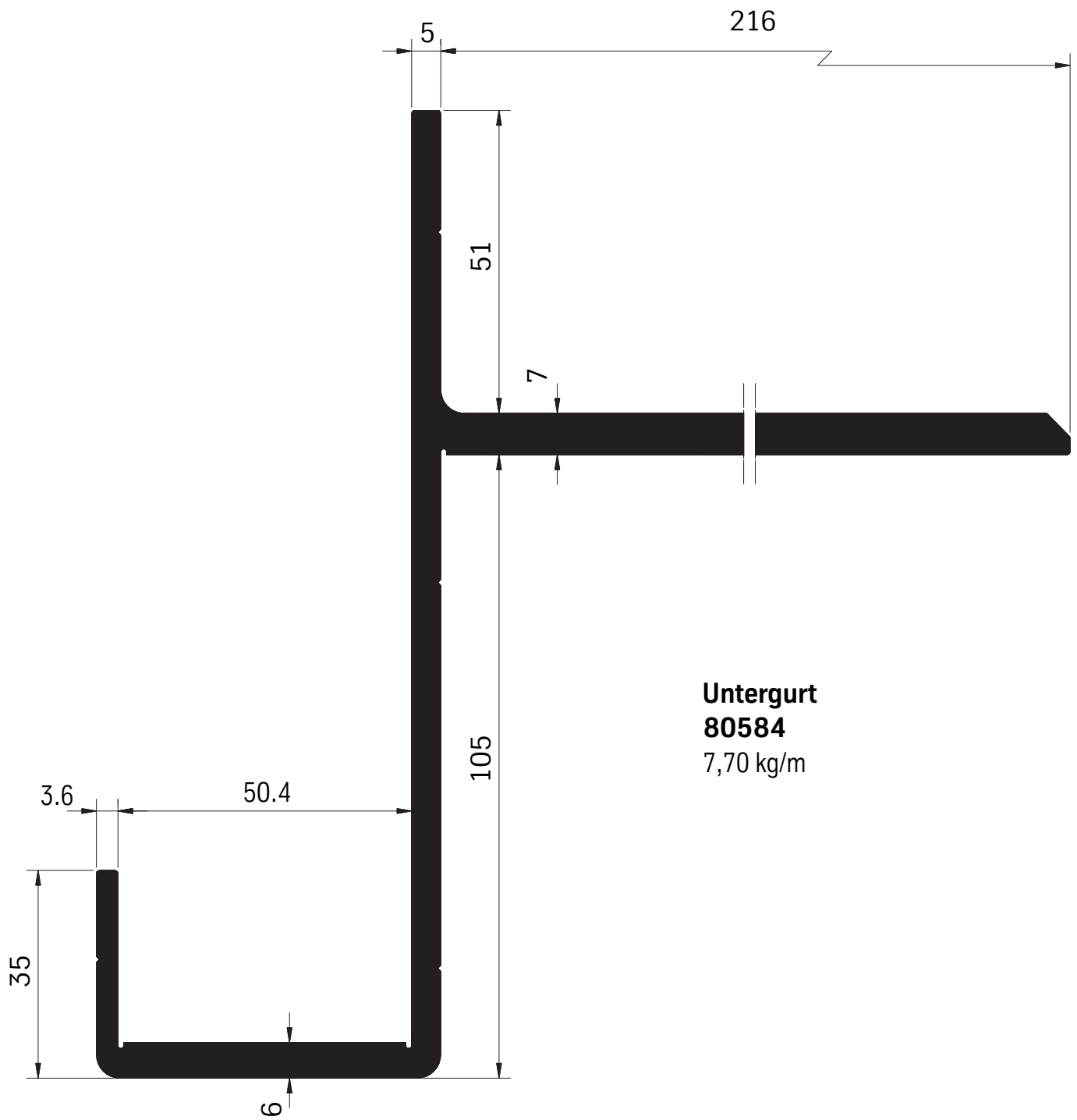

Mulden-System 50 mm

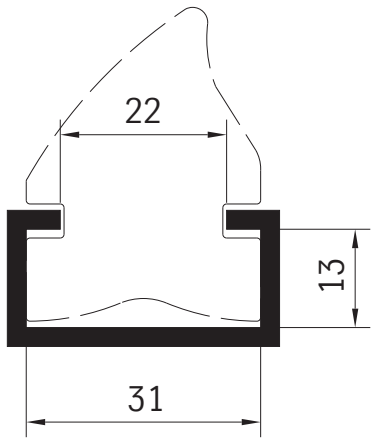

**C-Schiene
80211**
0,52 kg/m

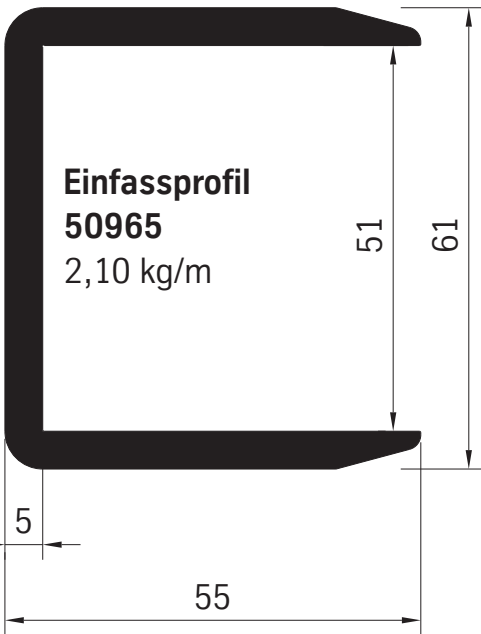

**Einfassprofil
50965**
2,10 kg/m

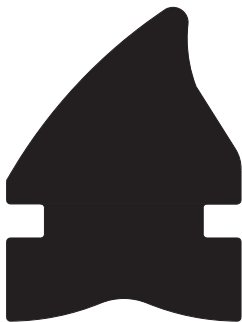

**Dichtung
50214**

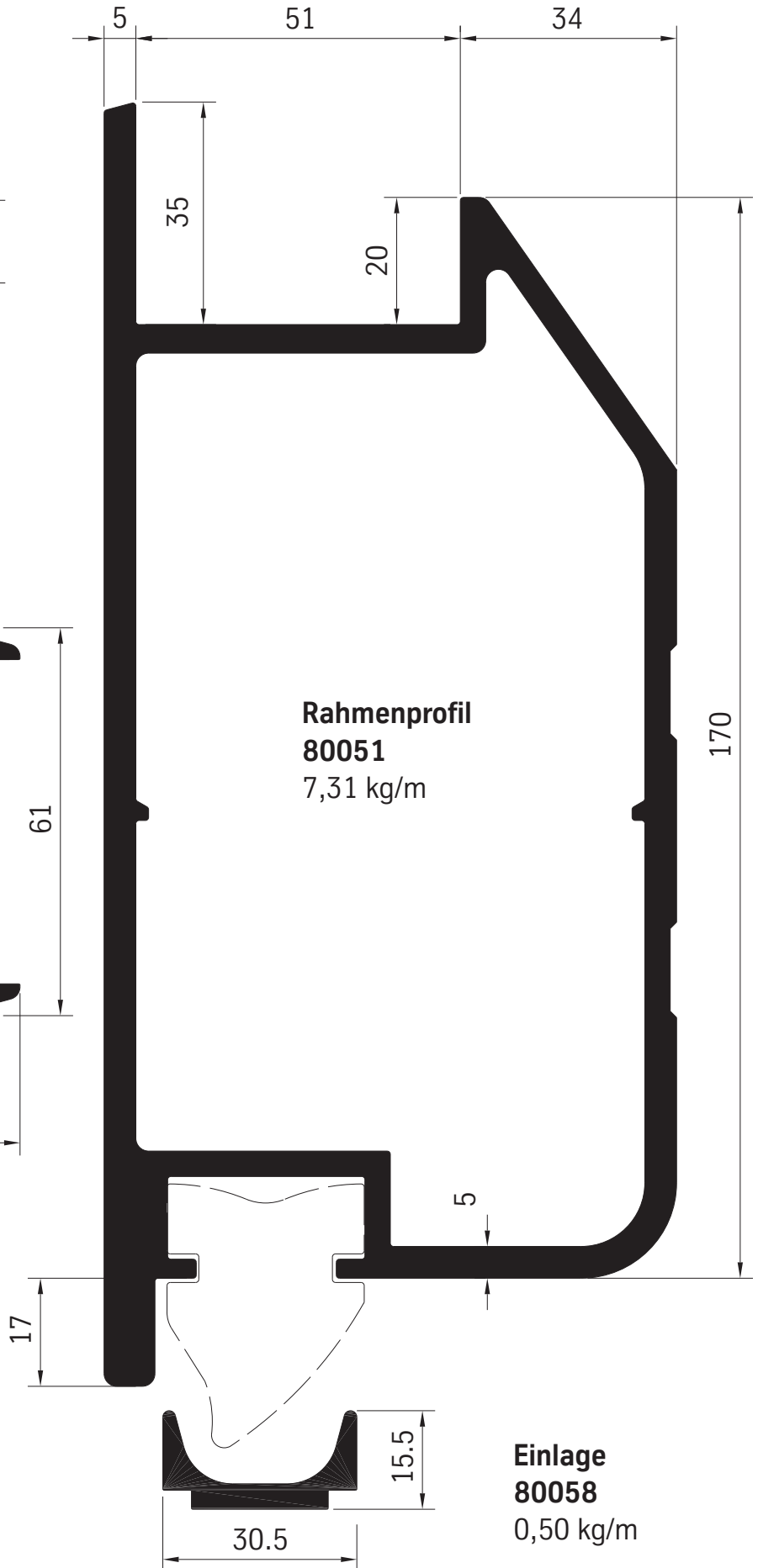

**Rahmenprofil
80051**
7,31 kg/m

**Einlage
80058**
0,50 kg/m

Mulden-System 40 mm

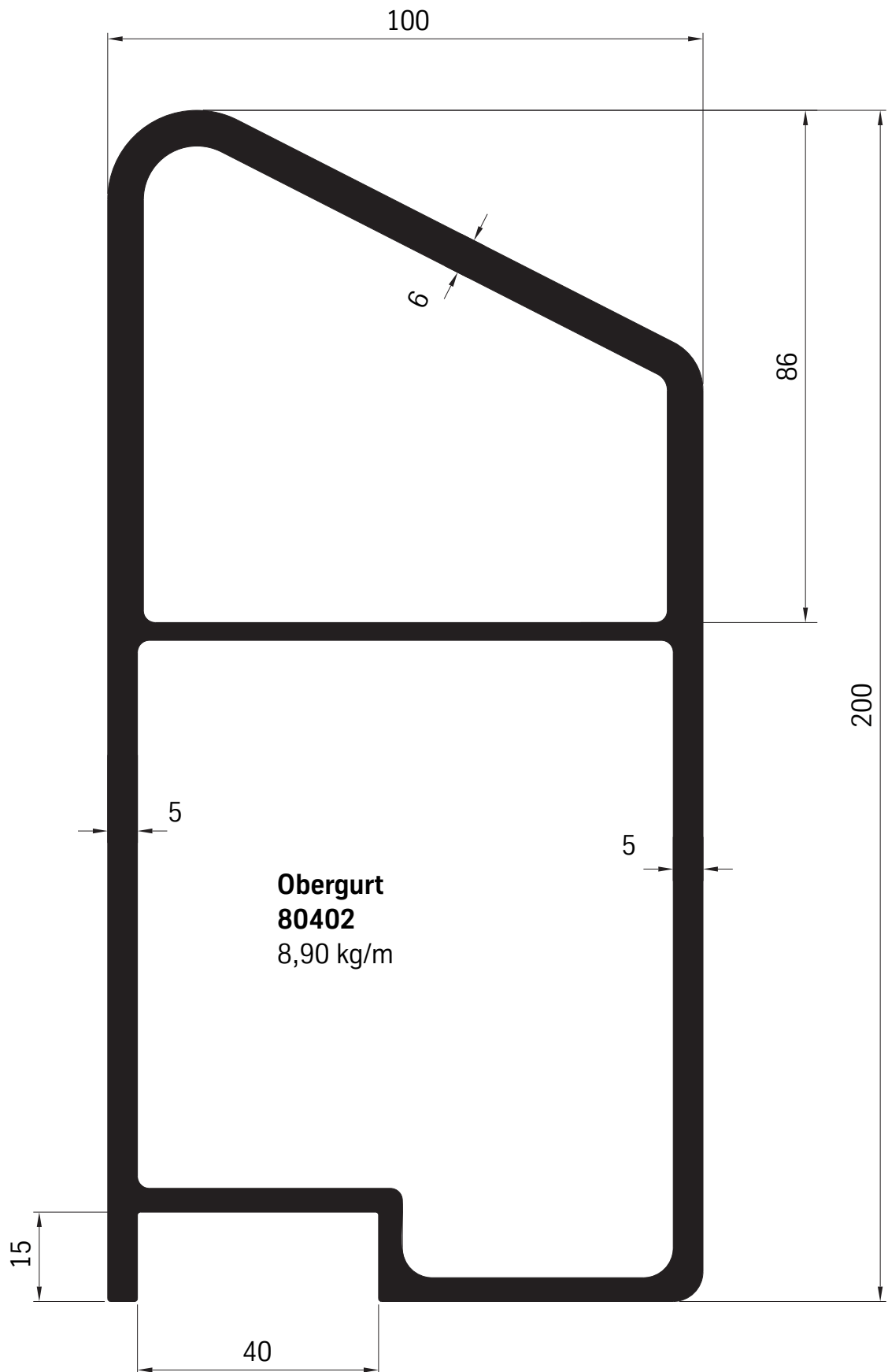

Mulden-System 40 mm

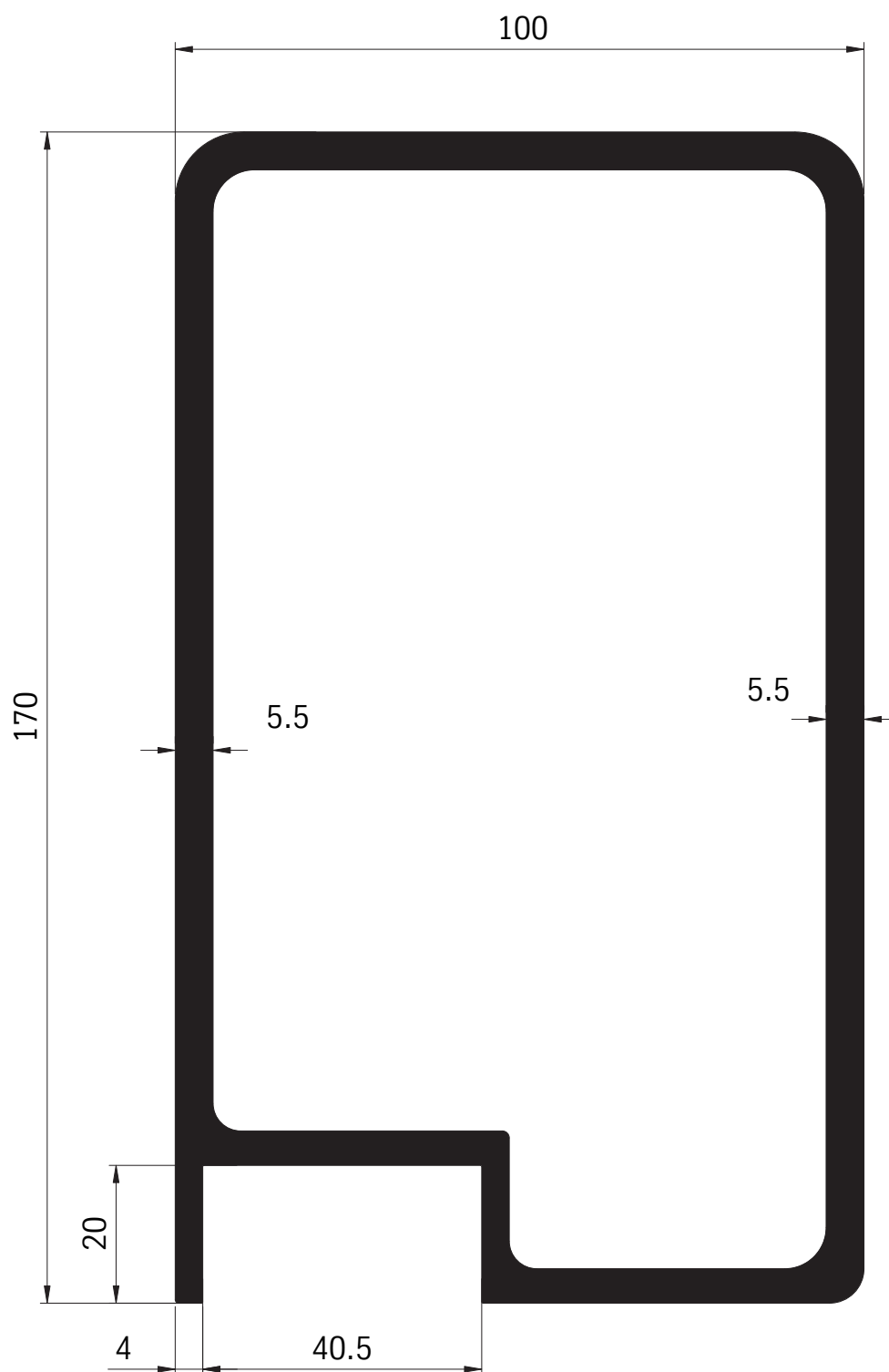

80403
7,95 kg/m

Mulden-System 40 mm

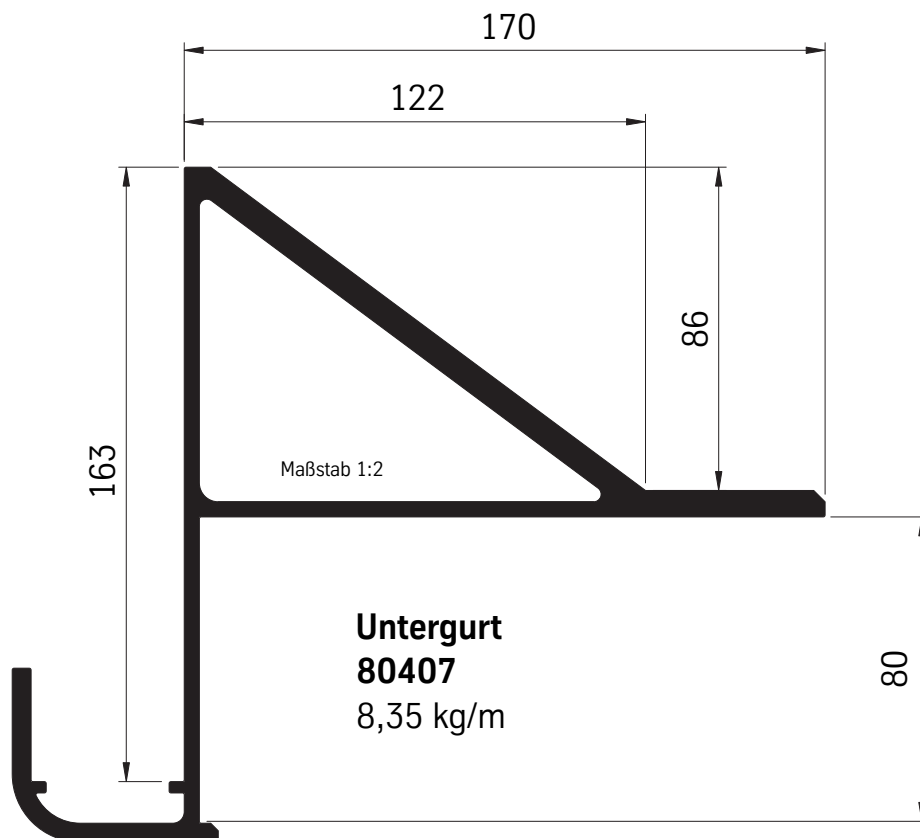
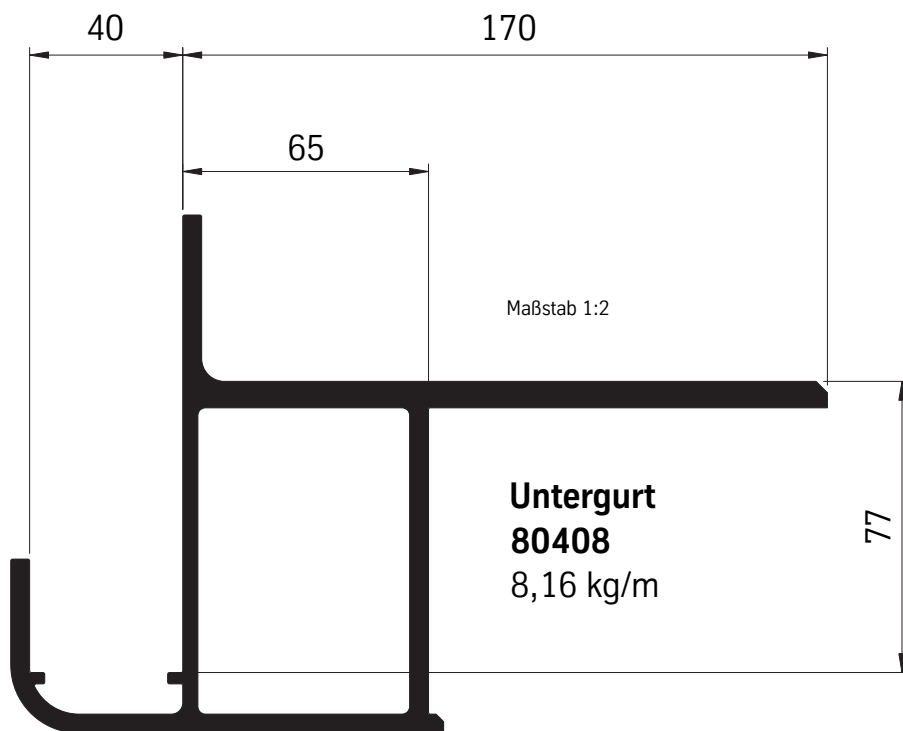

Mulden-System 40 mm

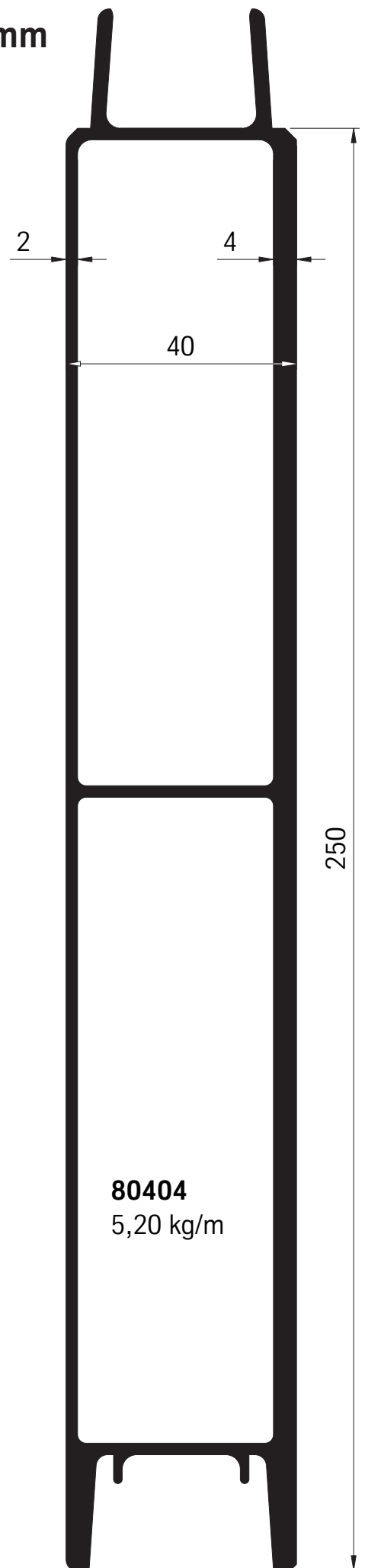
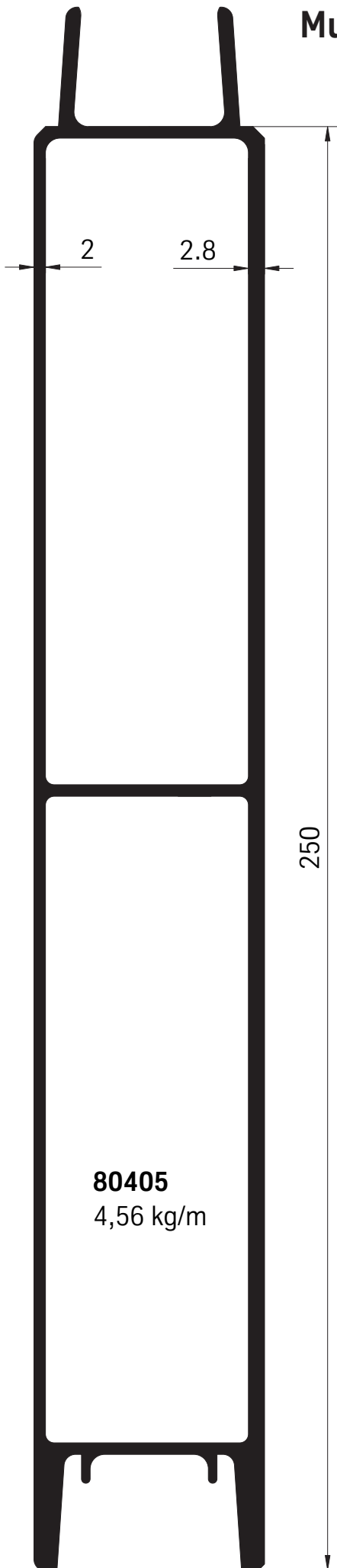

Mulden-System 40 mm

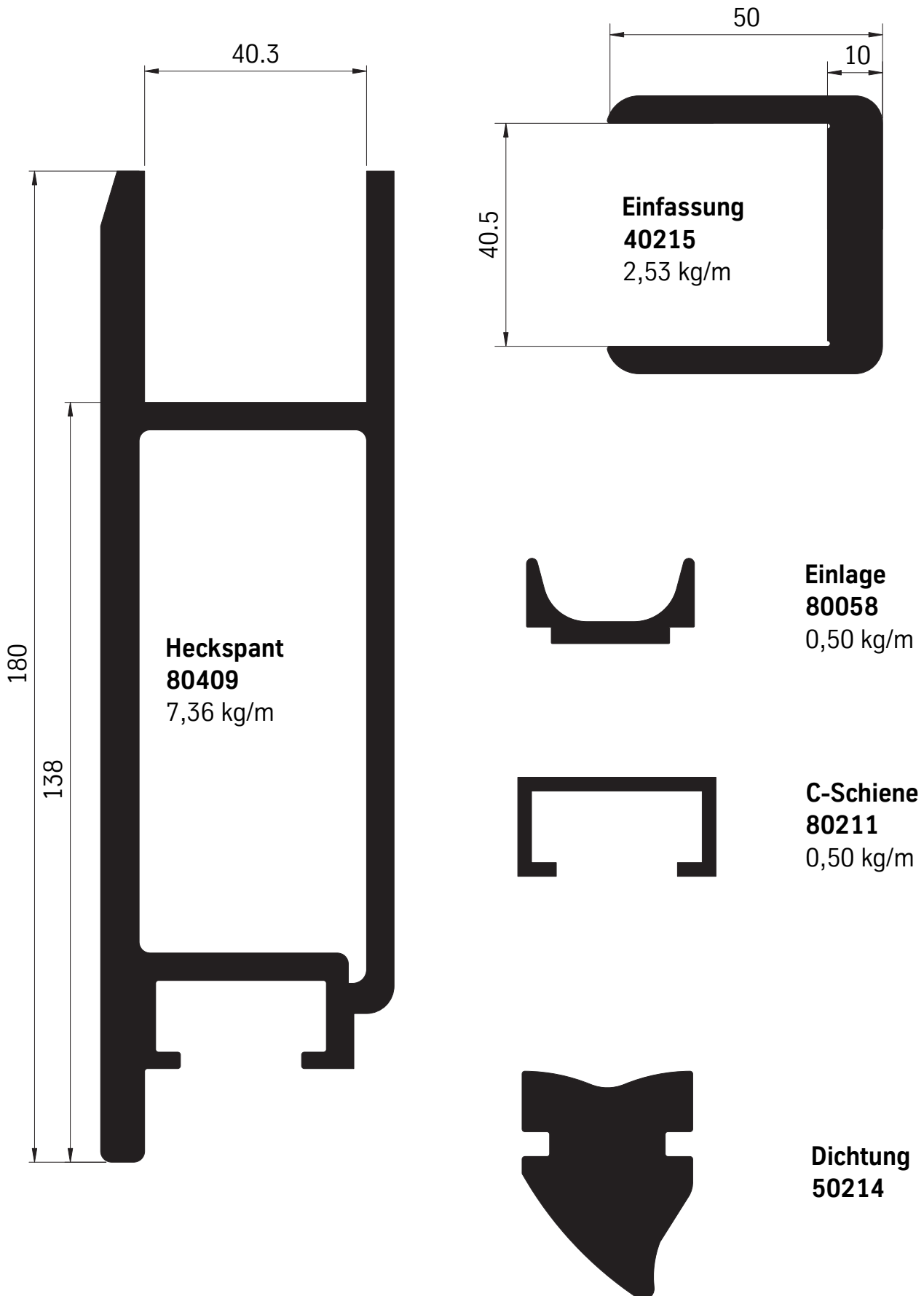

Mulden-System 40 mm

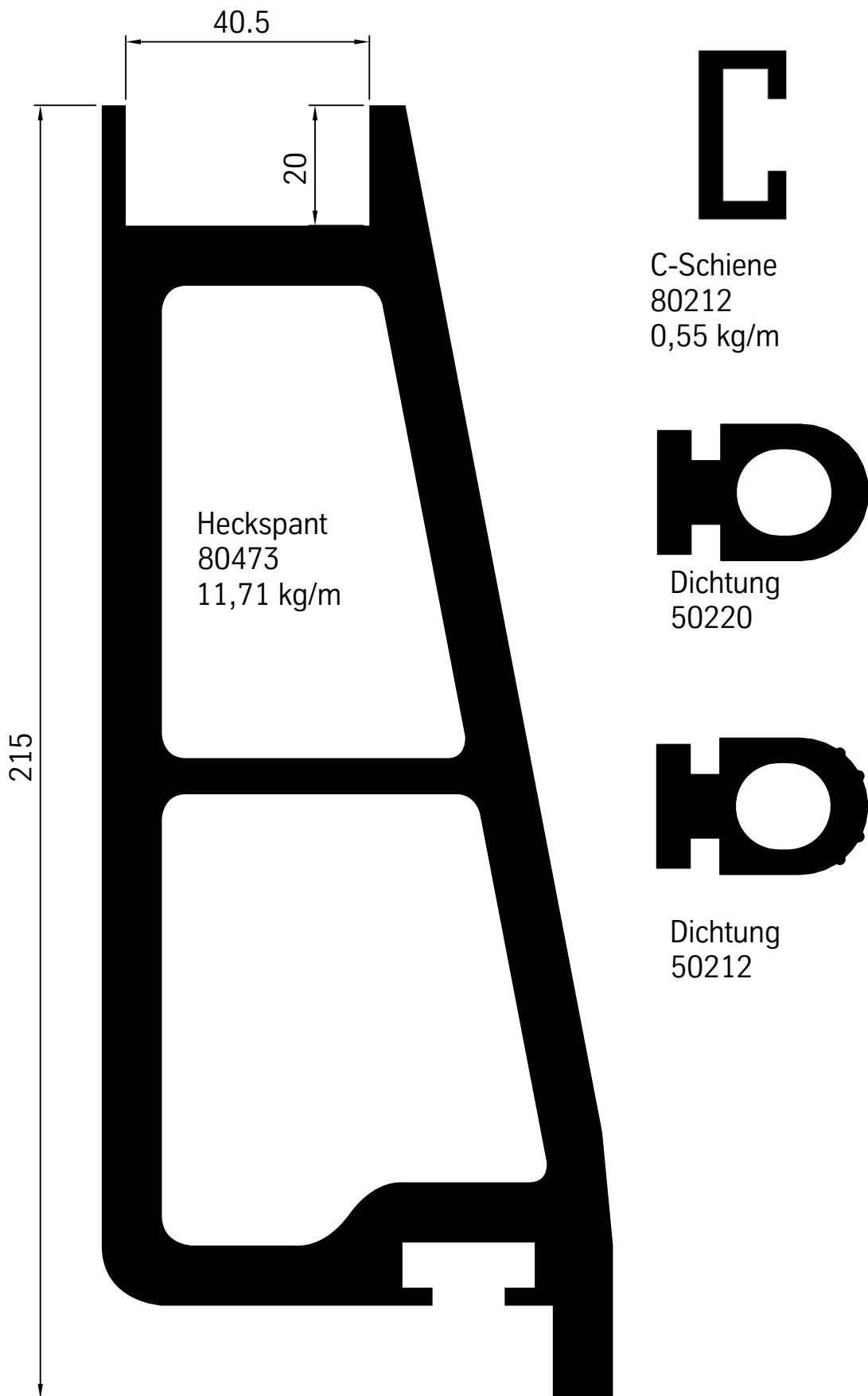

Mulden-System 40 mm

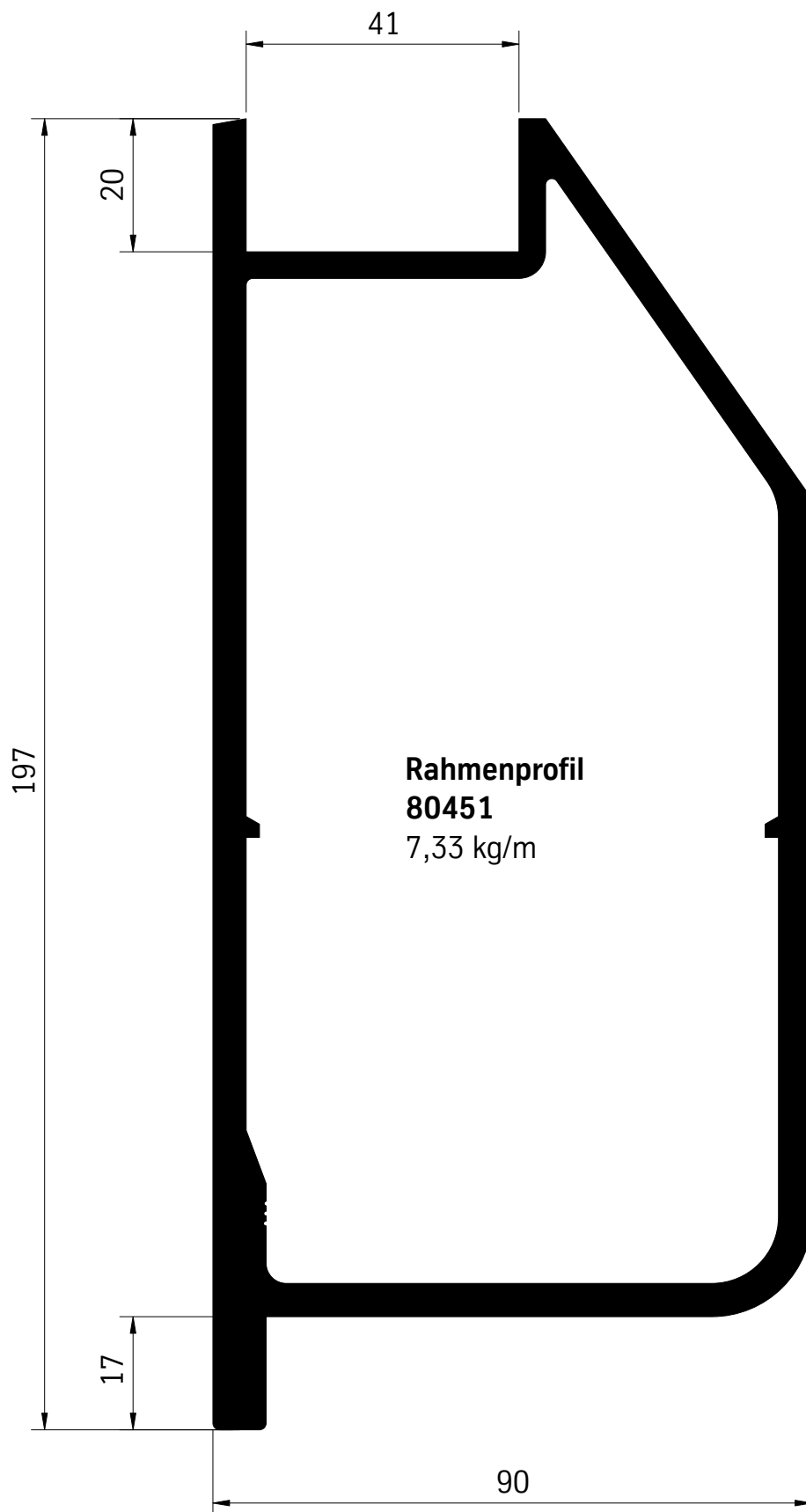

Mulden-System 40 mm

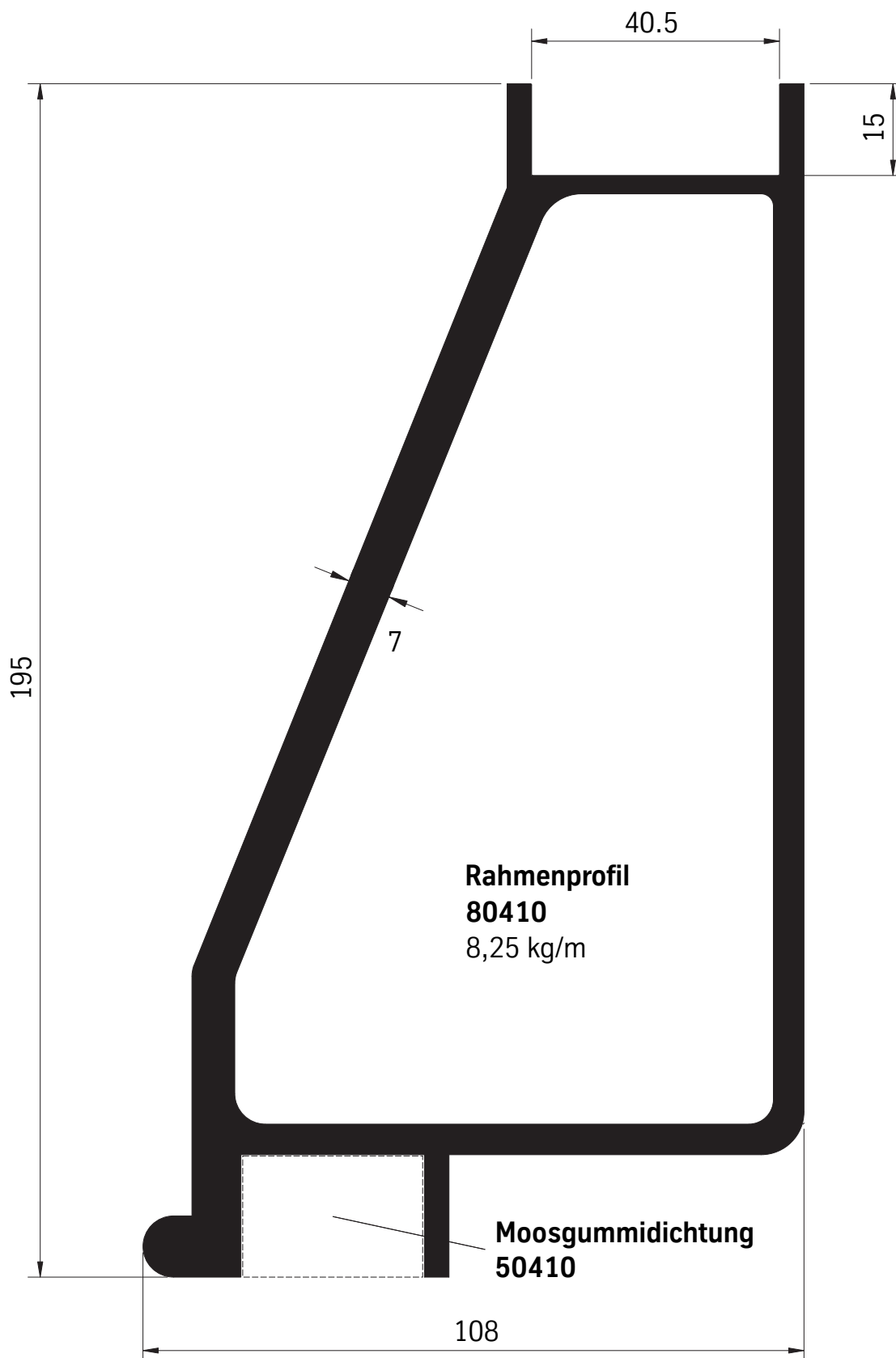

Mulden-System 30 mm

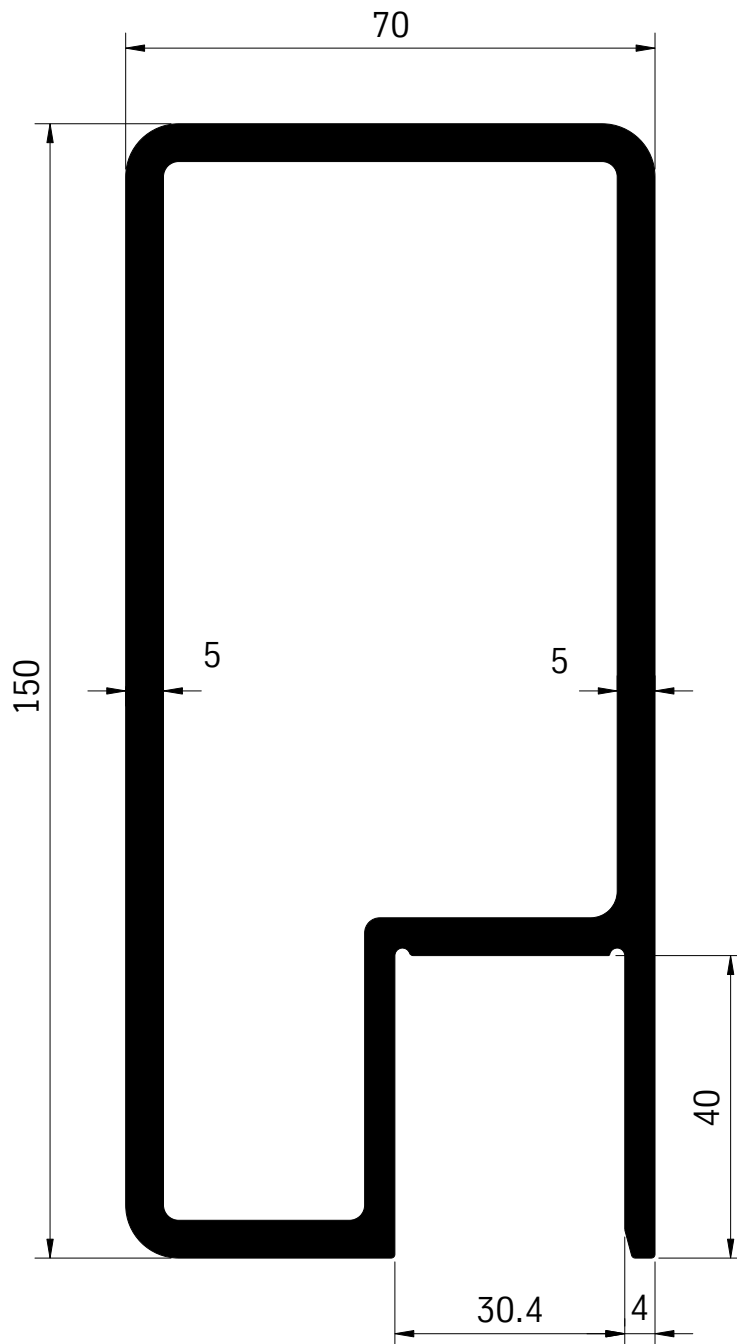

Obergurtprofil

80818

5,91 kg/m

Mulden-System 30 mm

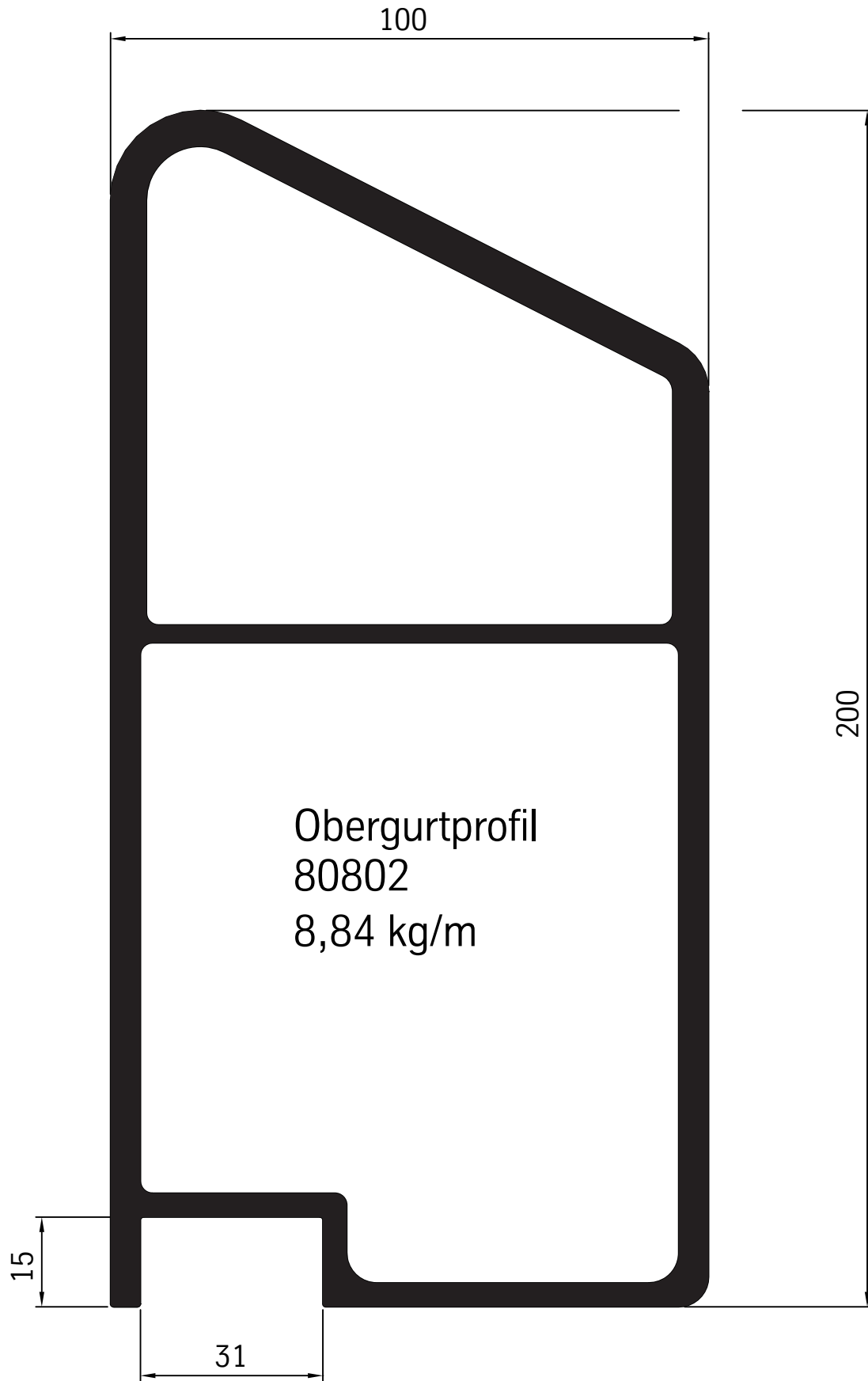

Mulden-System 30 mm

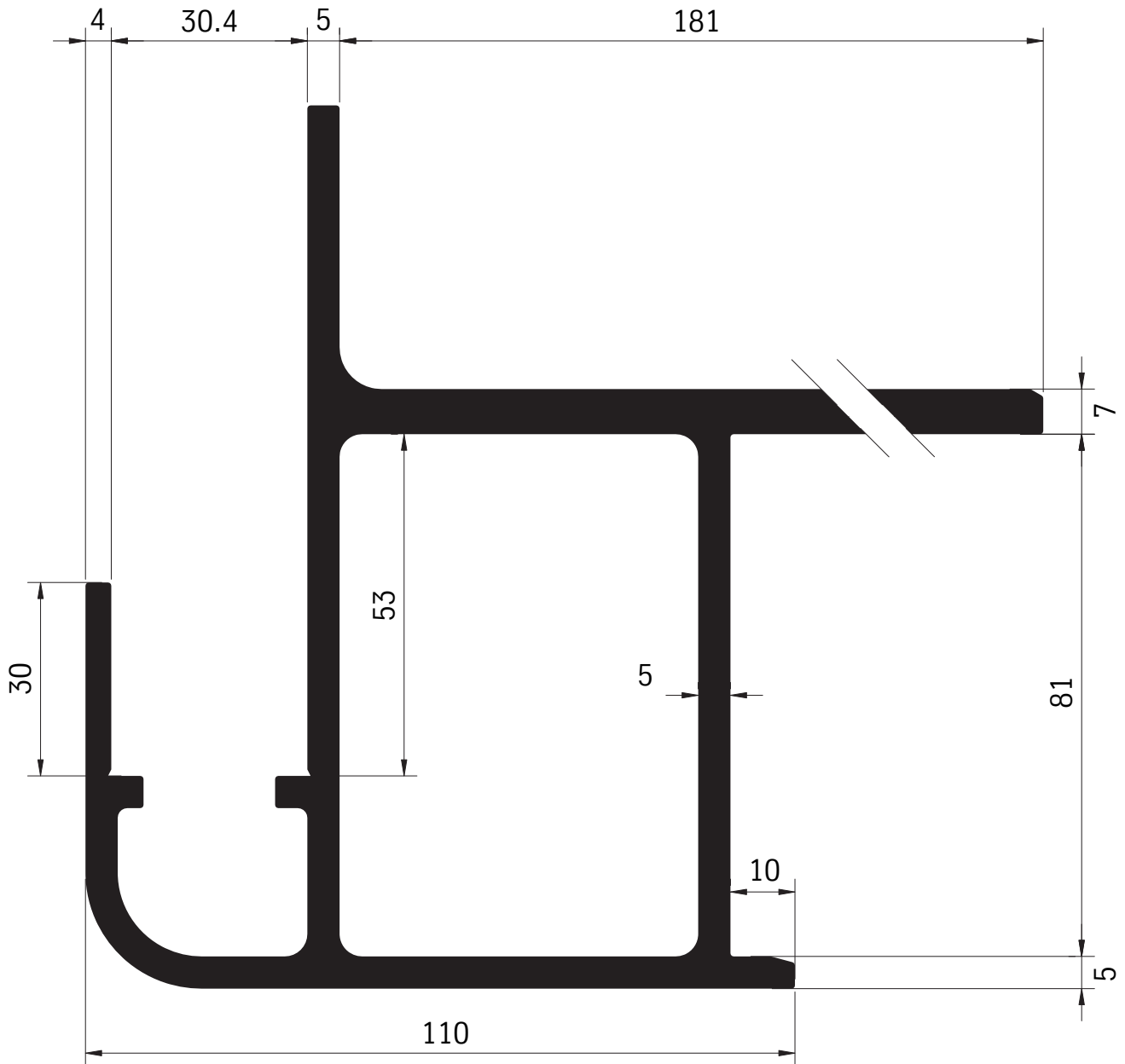

Untergurtprofil
80819
8,56 kg/m

Mulden-System 30 mm

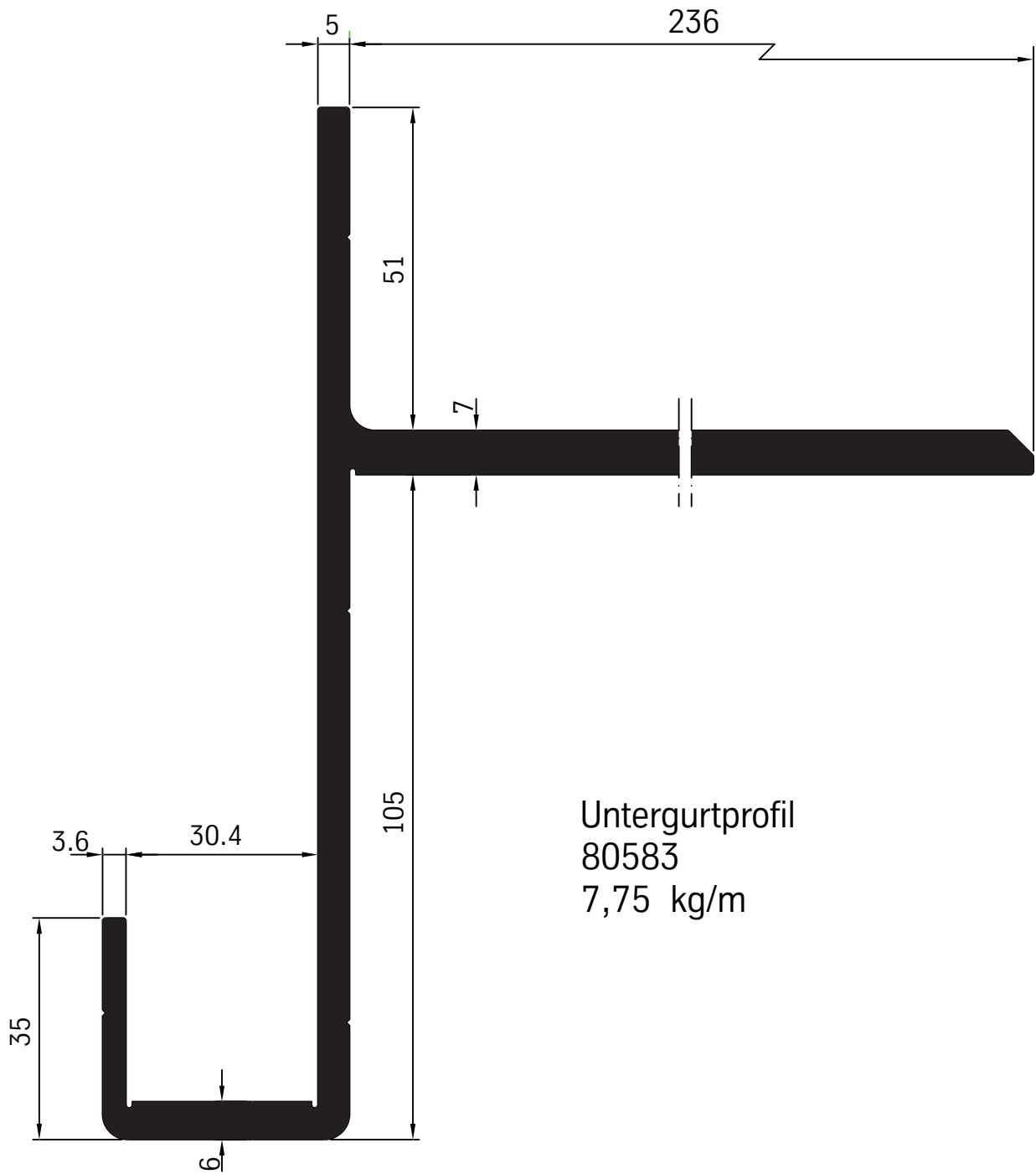

Mulden-System 30 mm

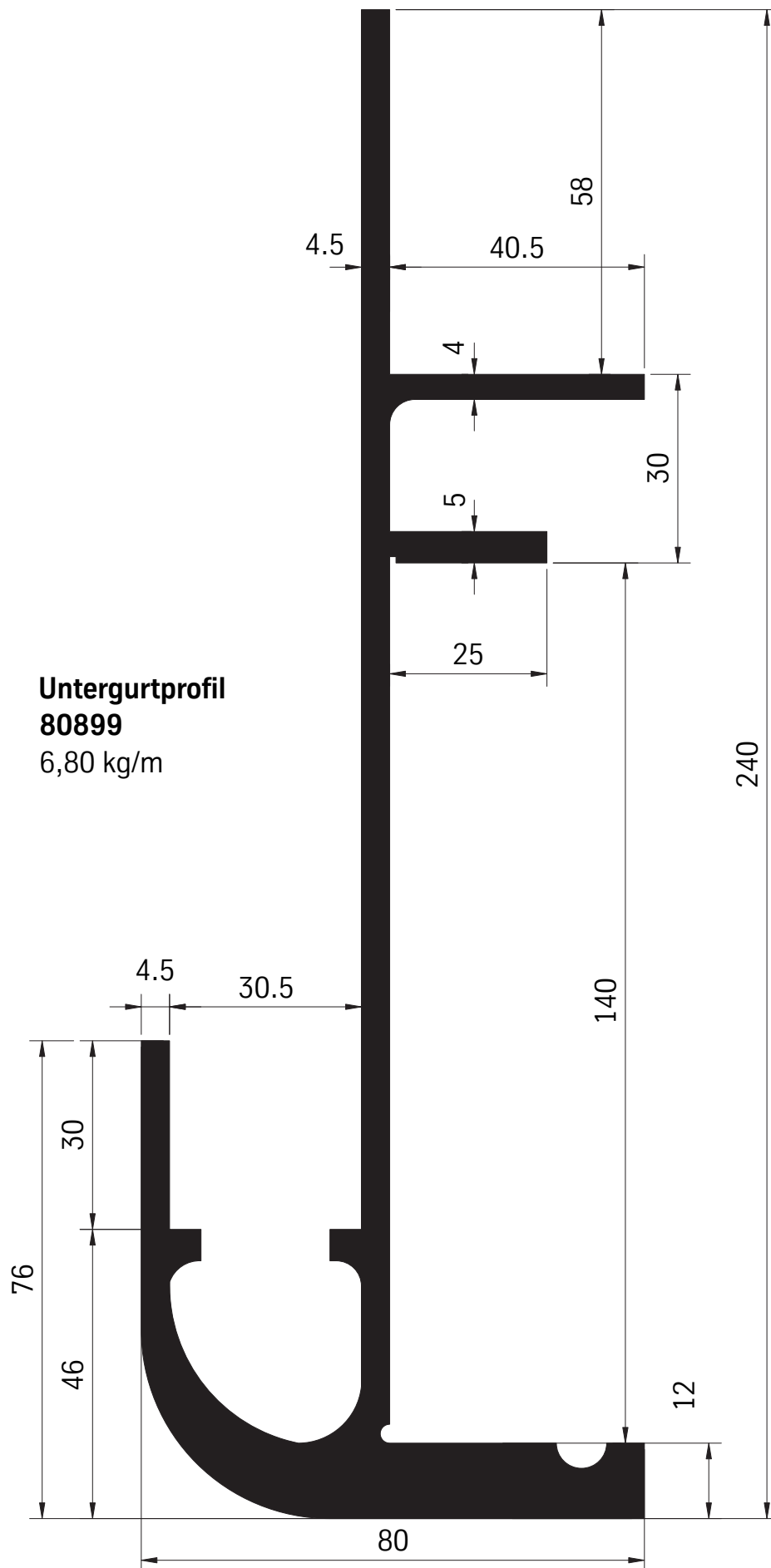

Untergurtprofil
80899
6,80 kg/m

Mulden-System 30 mm

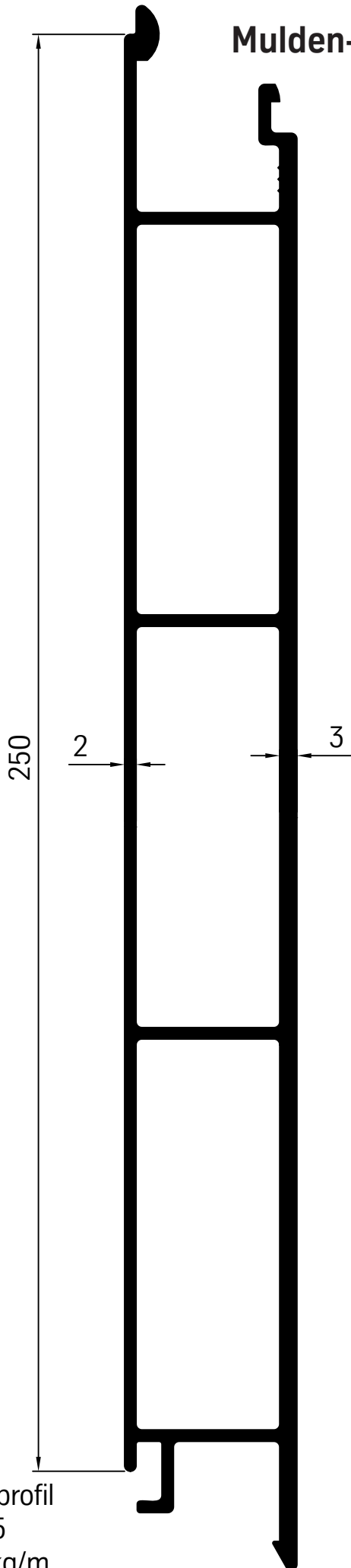

Wandprofil
80825
4,25 kg/m

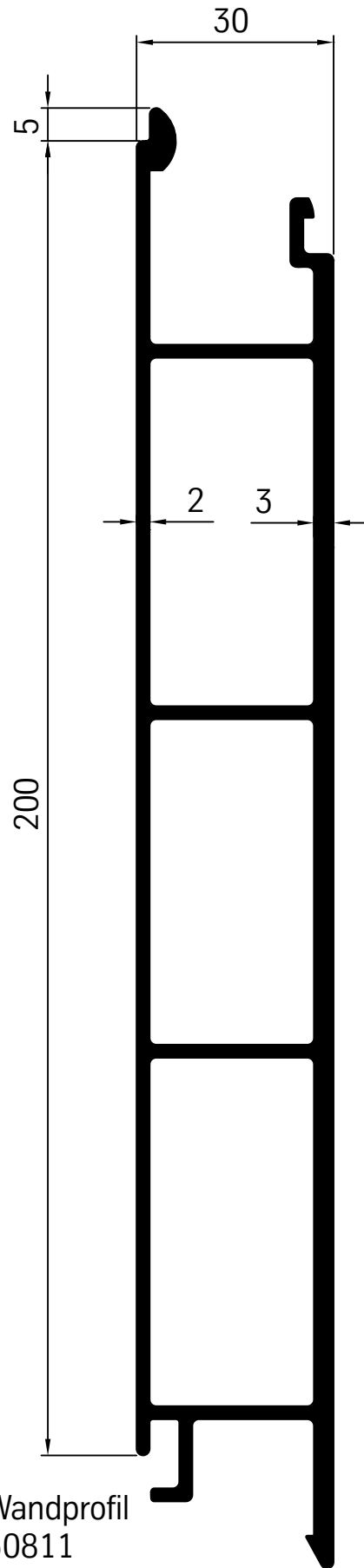

Wandprofil
30811
3,50 kg/m

Mulden-System 30 mm

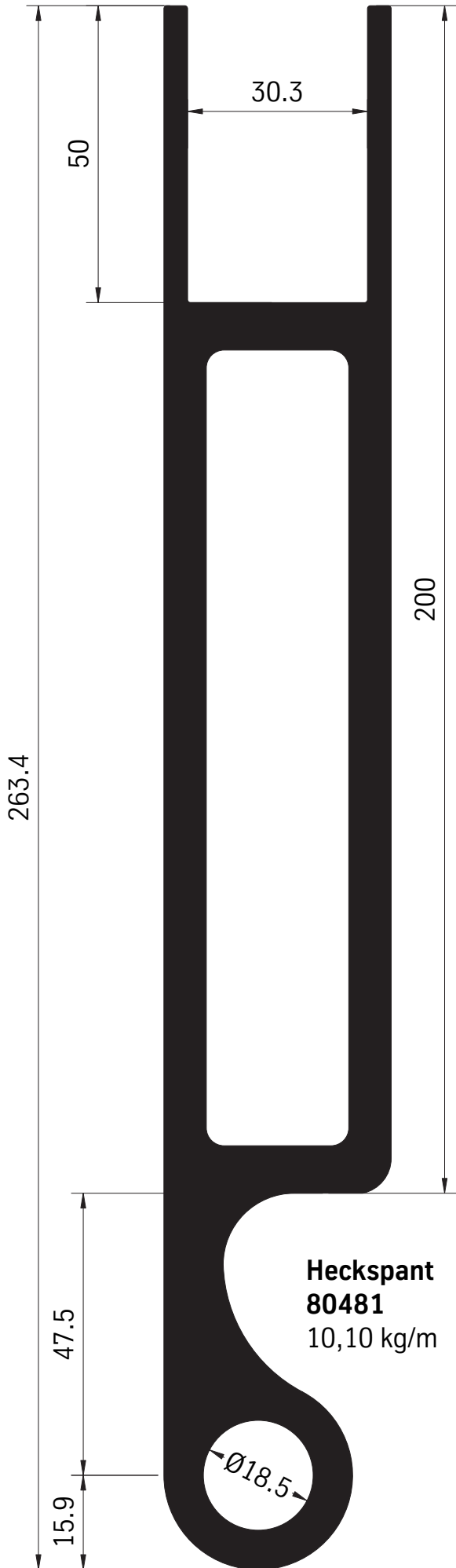

Mulden-System 30 mm

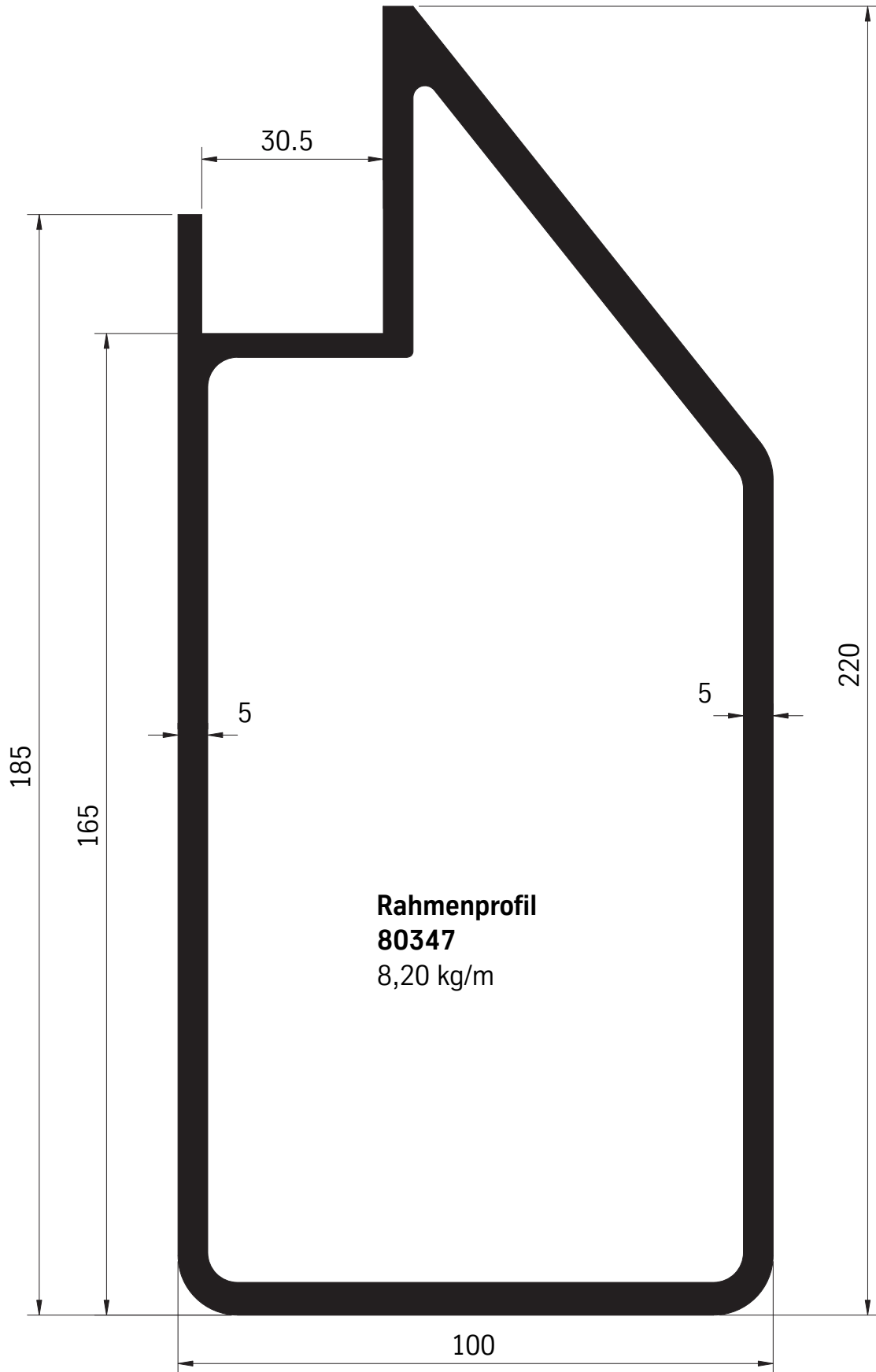

Mulden-System 30 mm

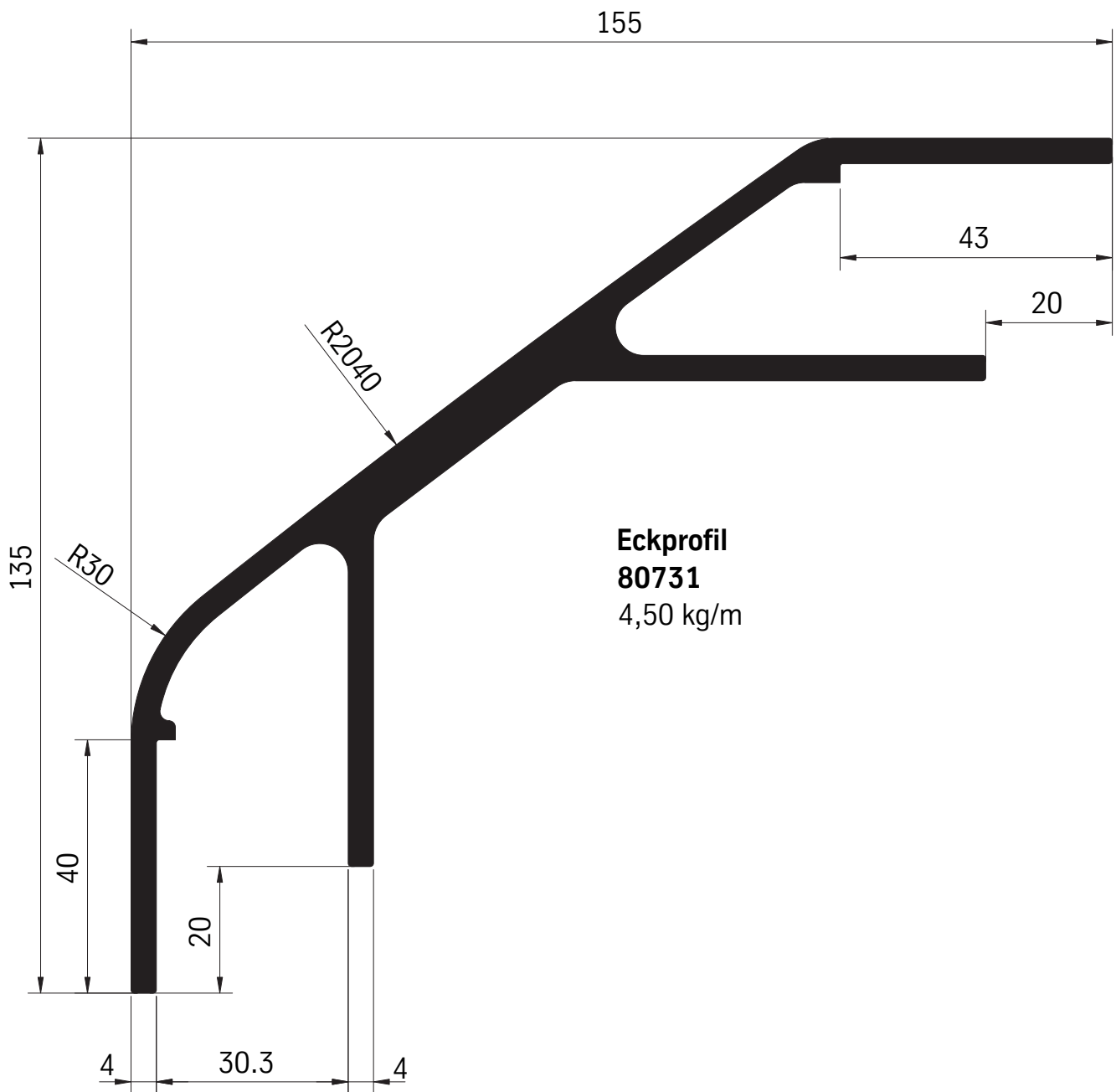

Eckprofil
80731
4,50 kg/m

Mulden-System 30 mm

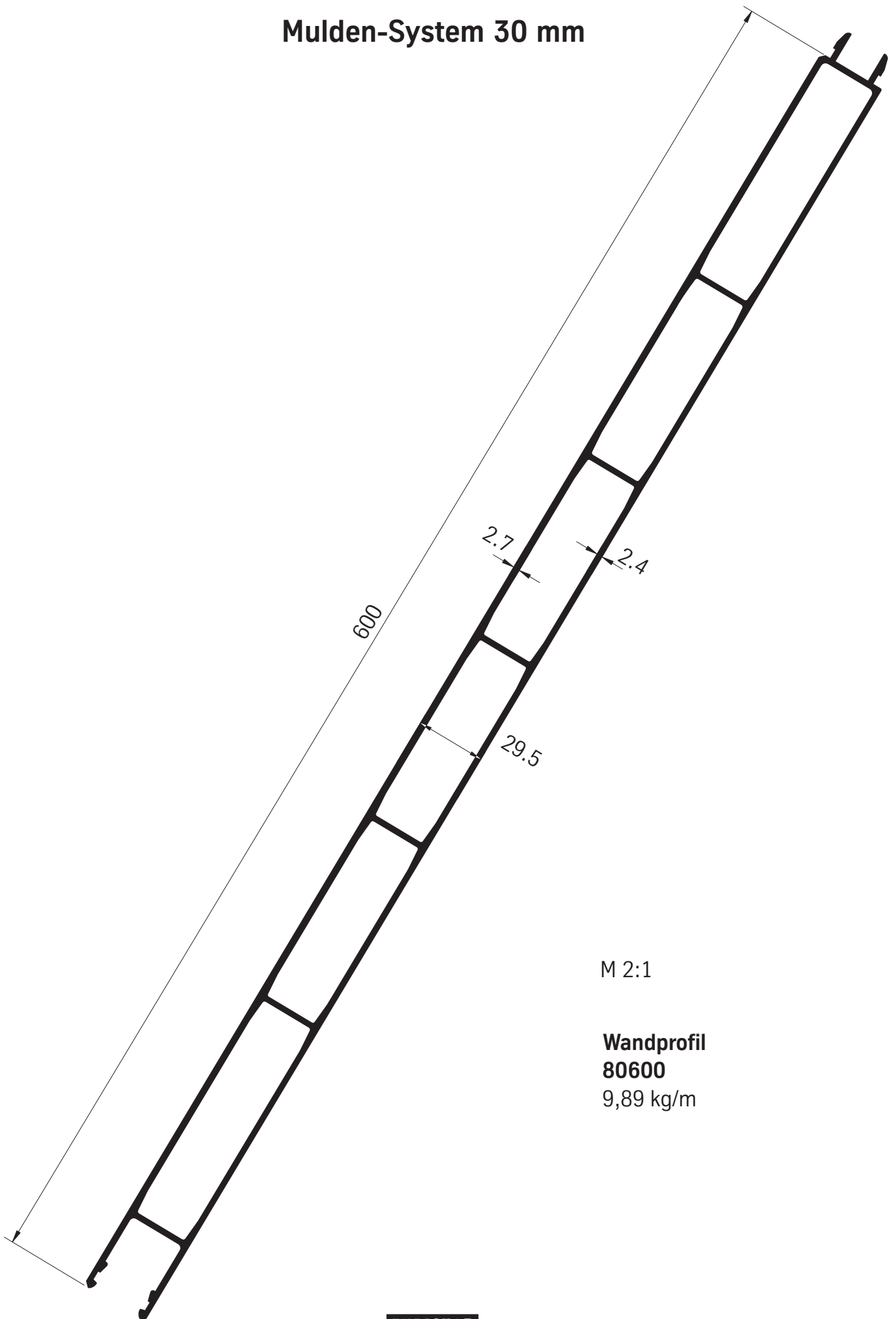

M 2:1

Wandprofil

80600

9,89 kg/m

Mulden-System 30 mm

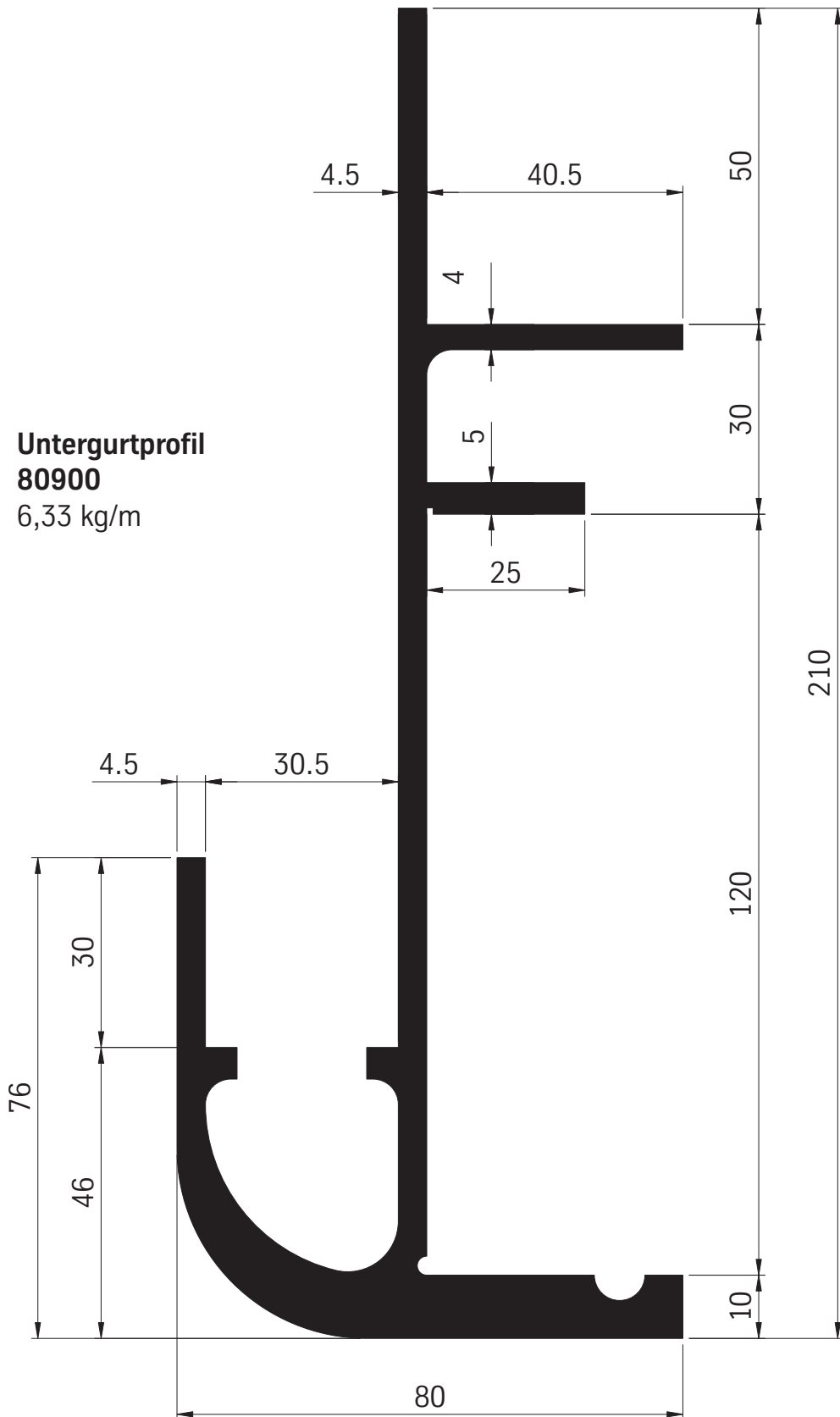

Mulden-System-Profile

Untergurtprofil
80902
4,27 kg/m

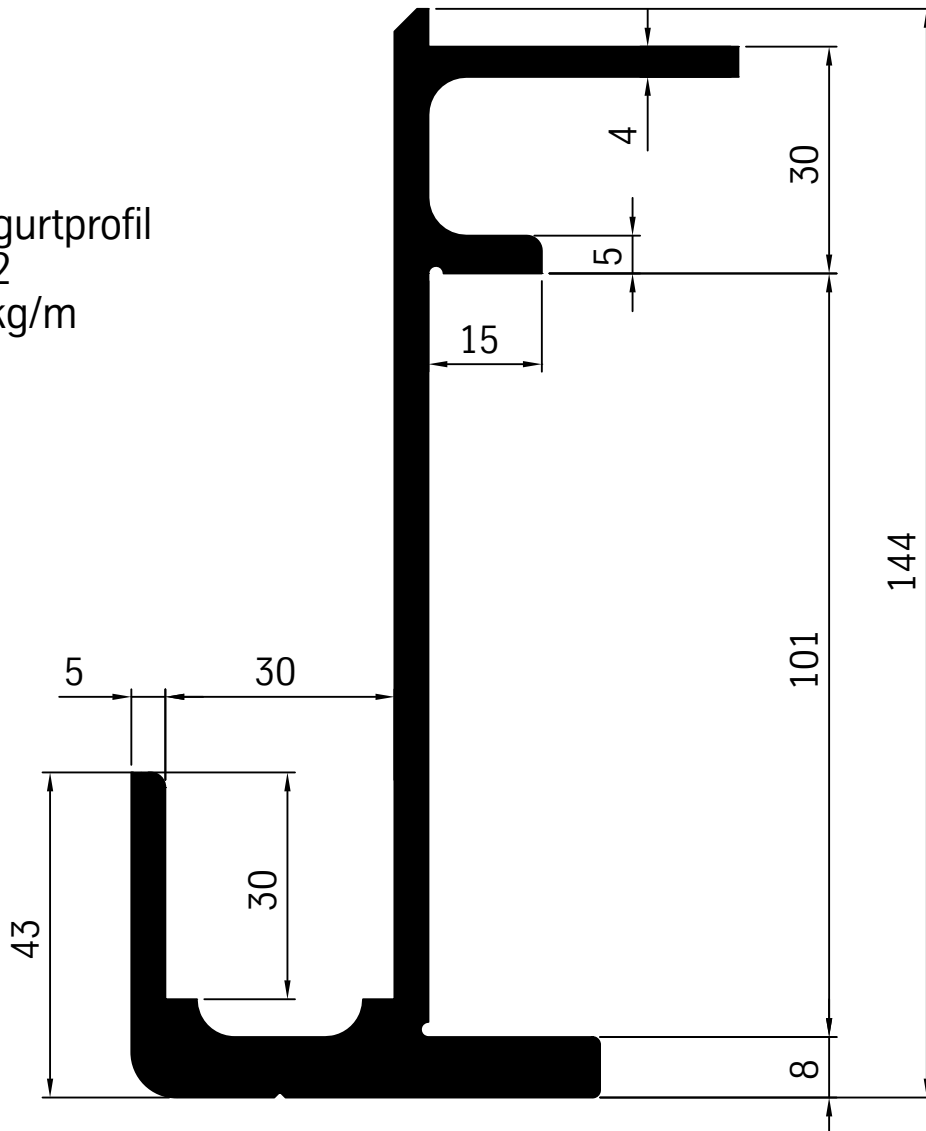

Mulden-System 30 mm

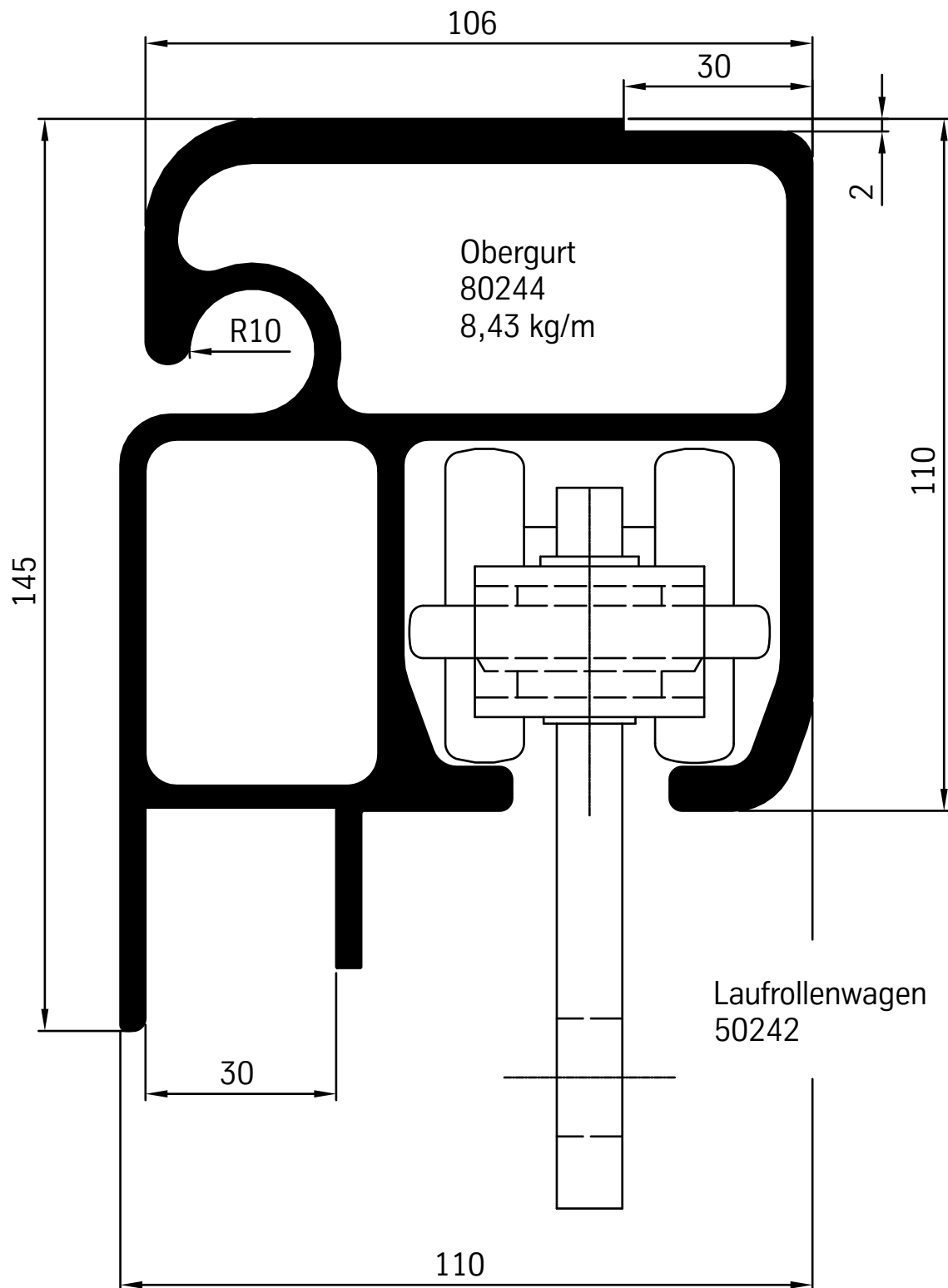

Mulden-System 30 mm

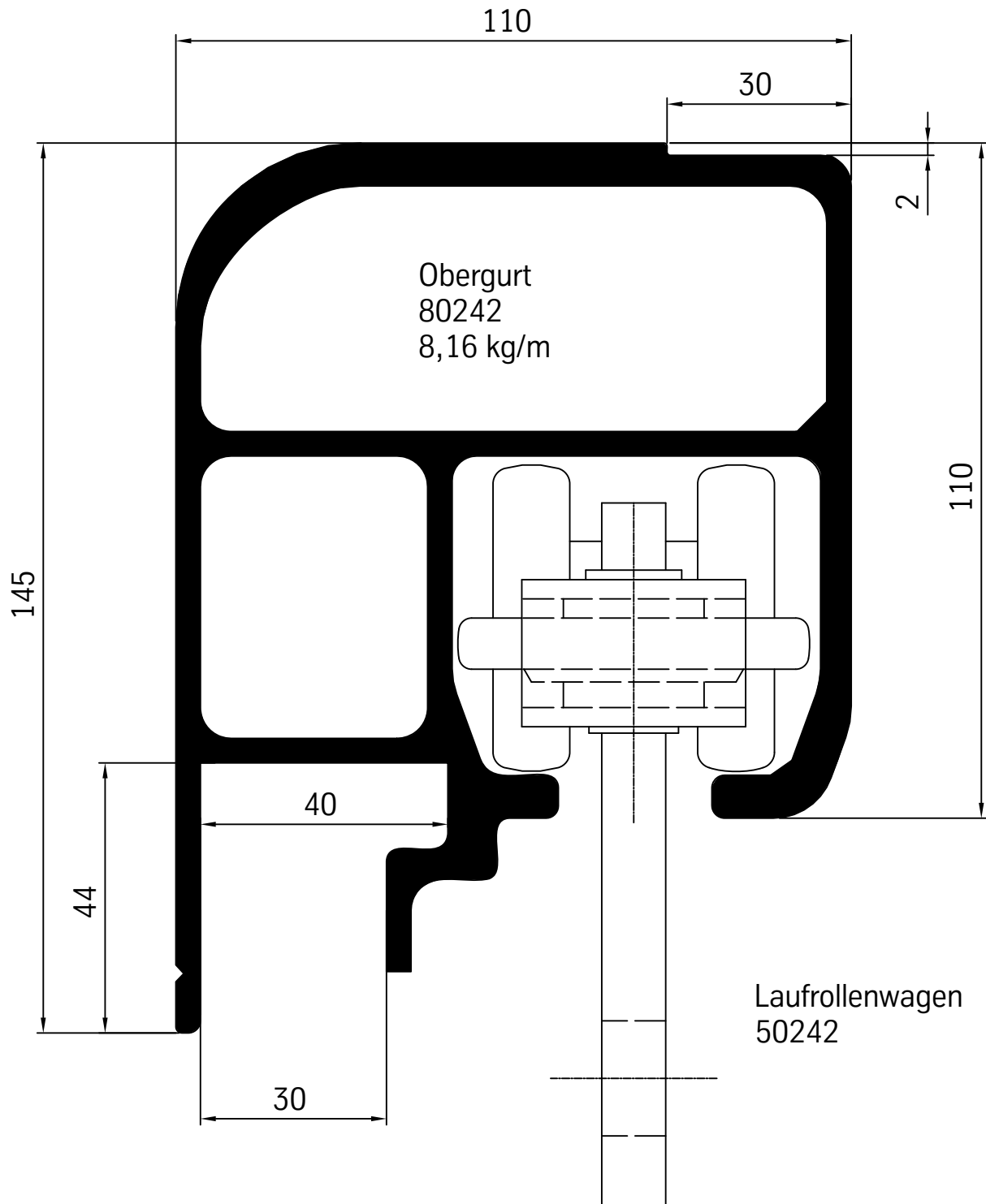

Mulden-System 30 mm

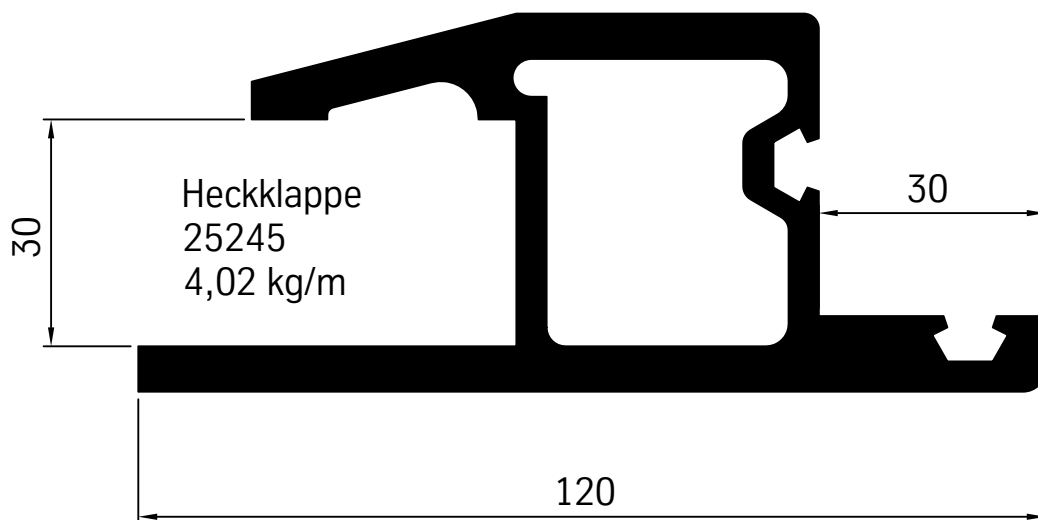
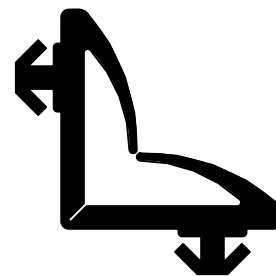
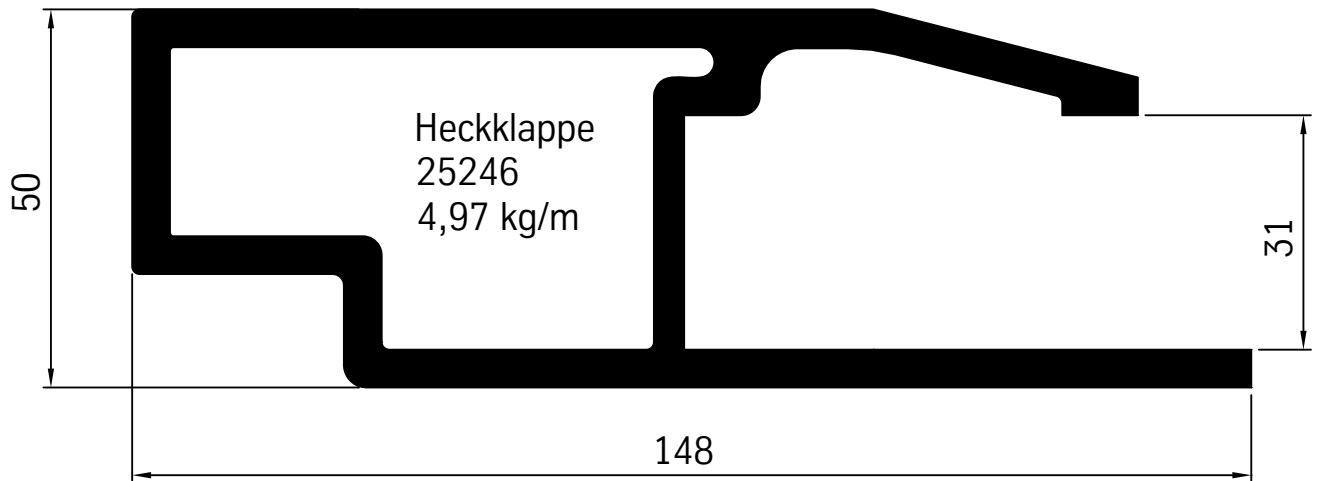

Spanten-Mulden-System

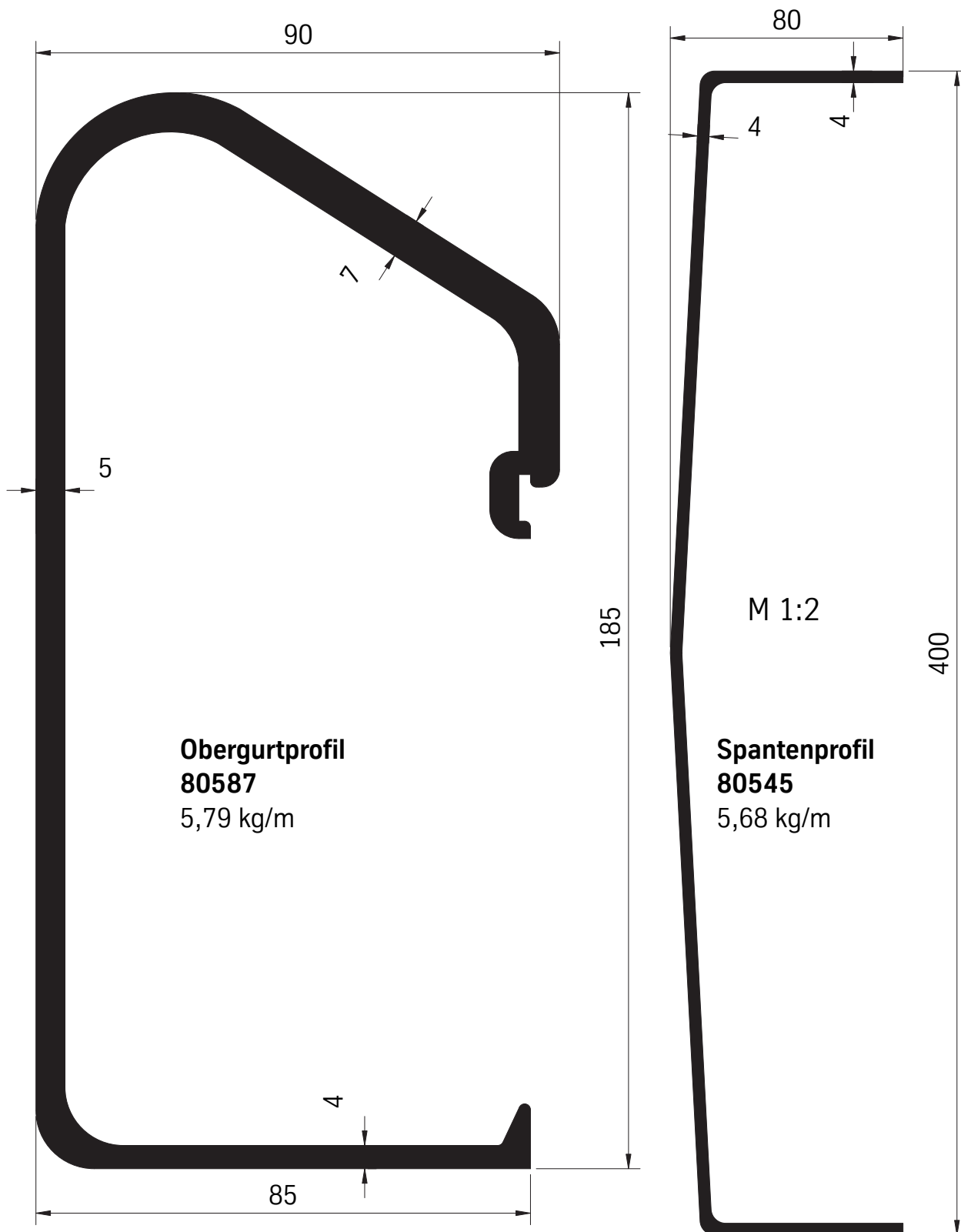

Spanten-Mulden-System

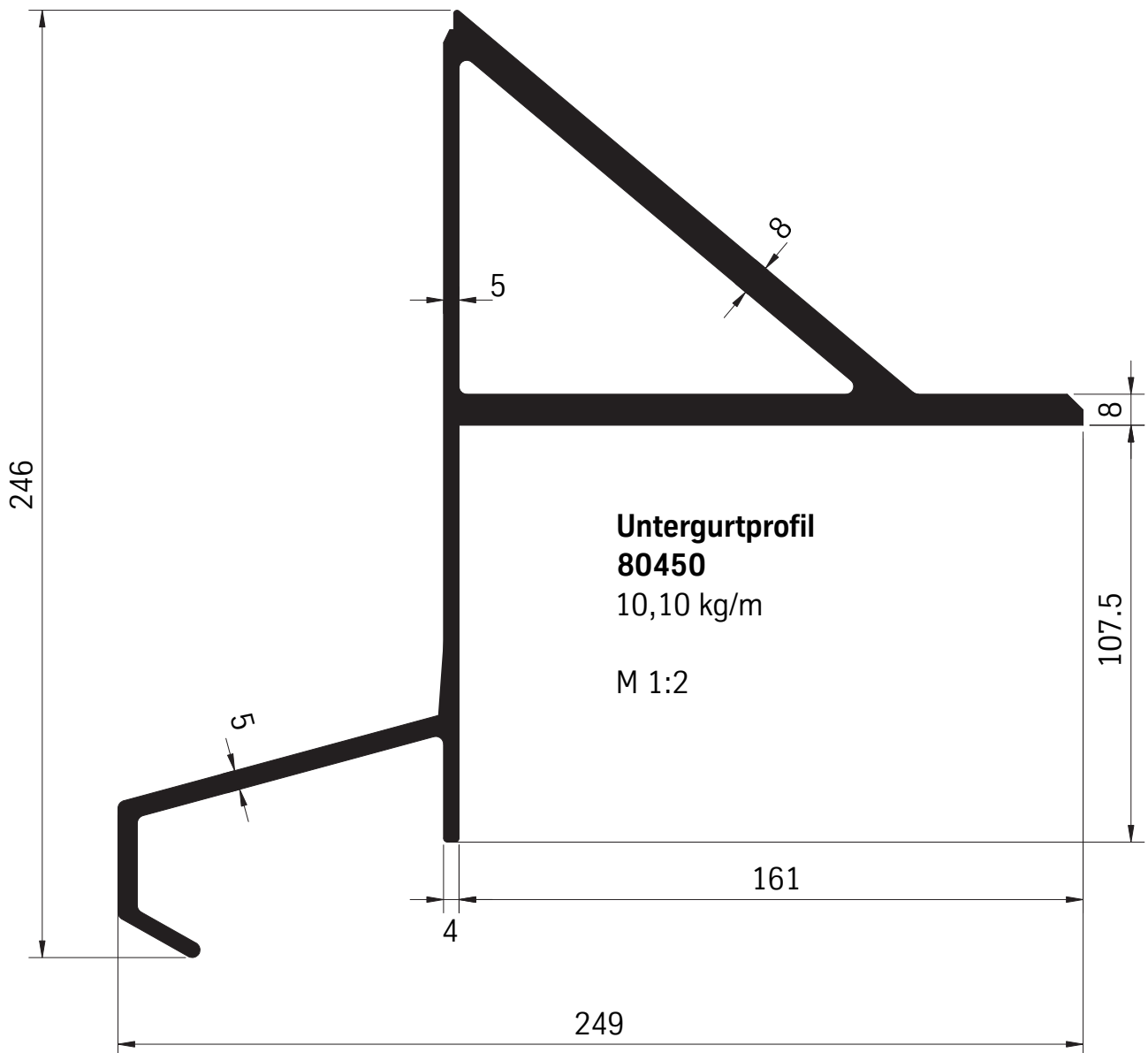

Spanten-Mulden-System

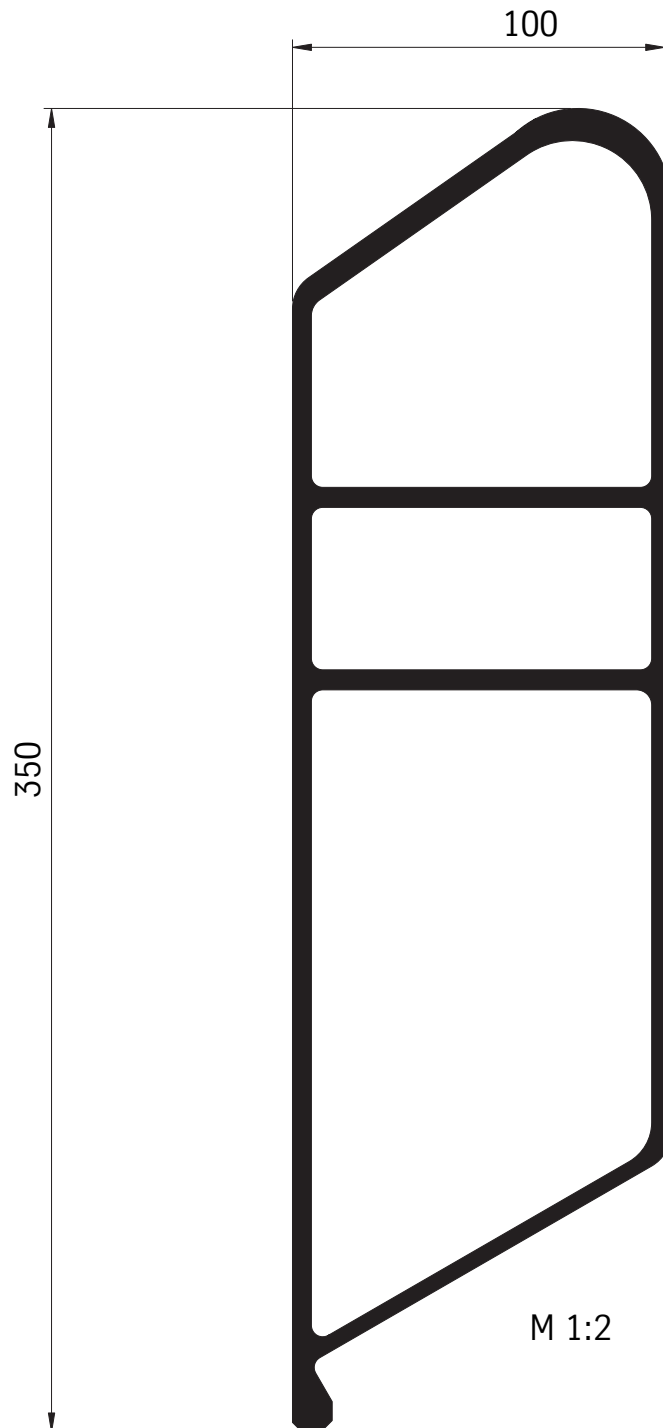

Obergurtprofil
80303
13,36 kg/m

Spanten-Mulden-System

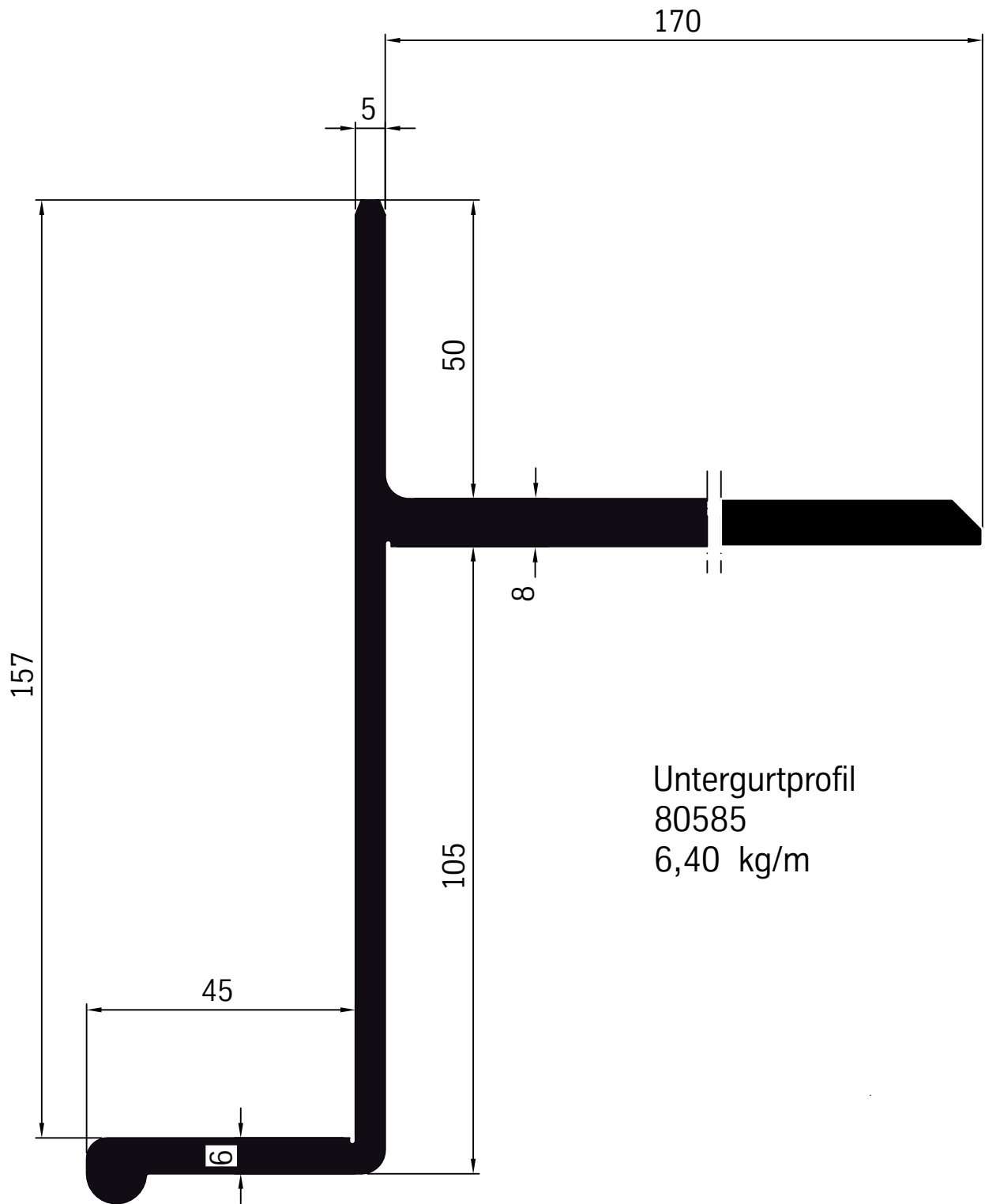

Untergurtprofil
80585
6,40 kg/m

Spanten-Mulden-System

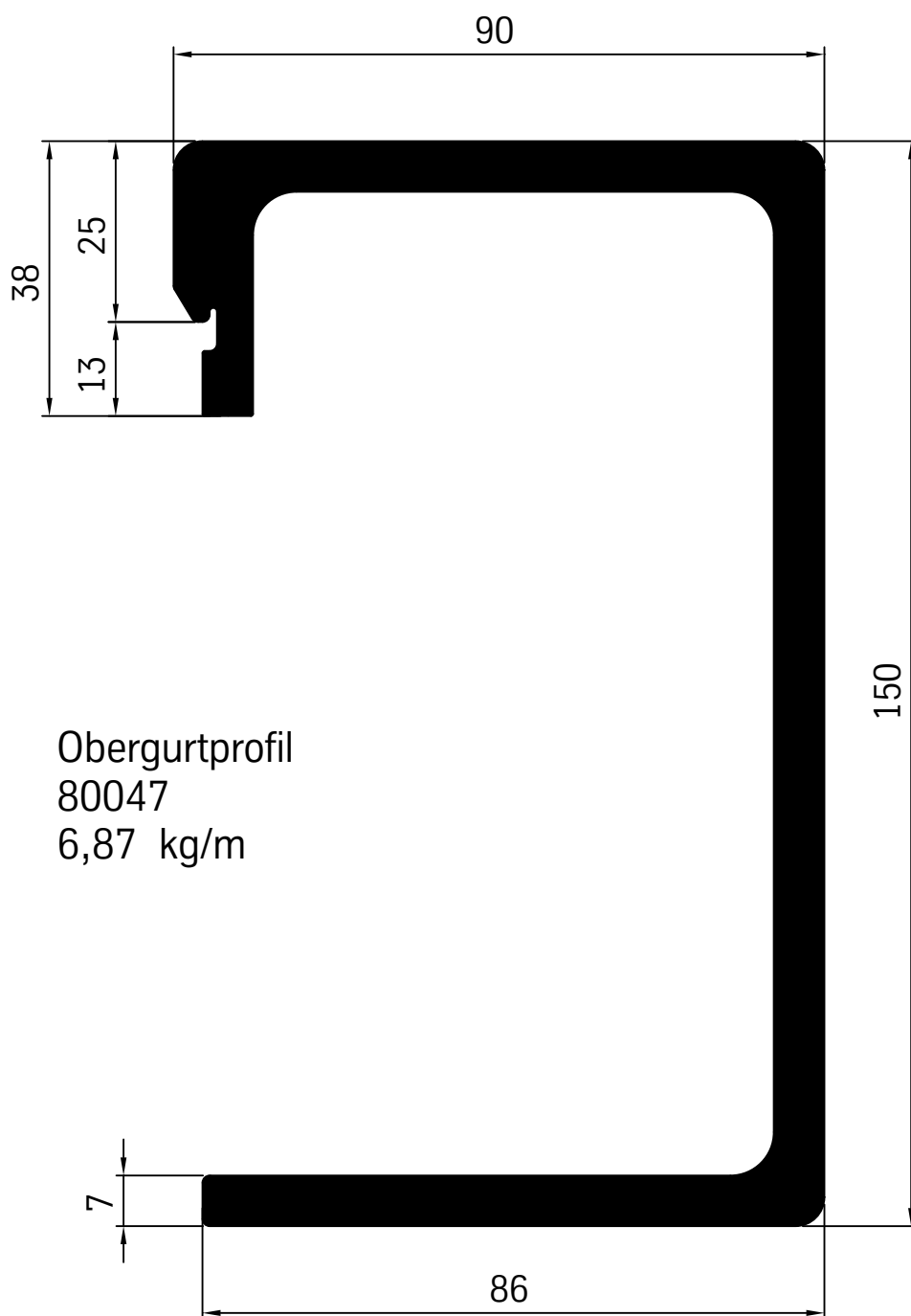

Obergurtprofil
80047
6,87 kg/m

Mulden-System-Profile

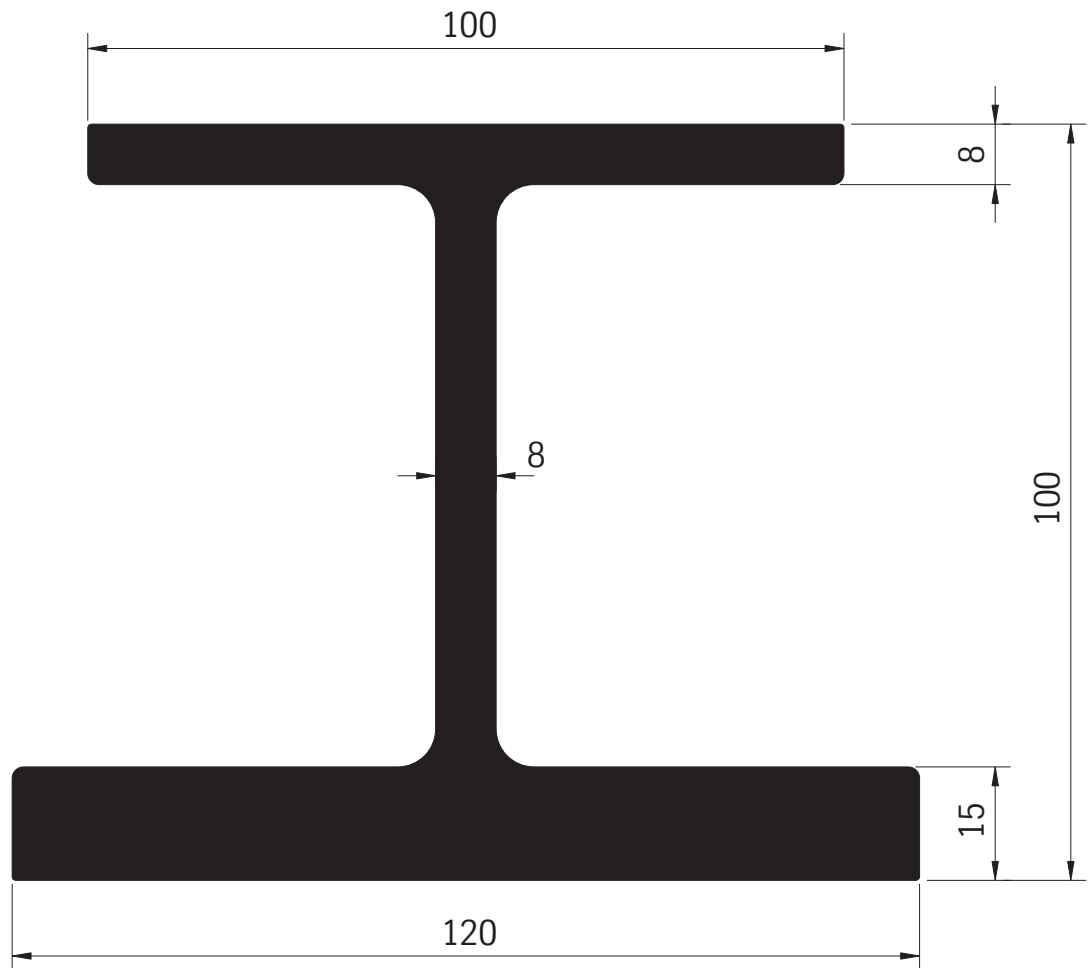

Trägerprofil
80067
9,20 kg/m

Mulden-System-Profile

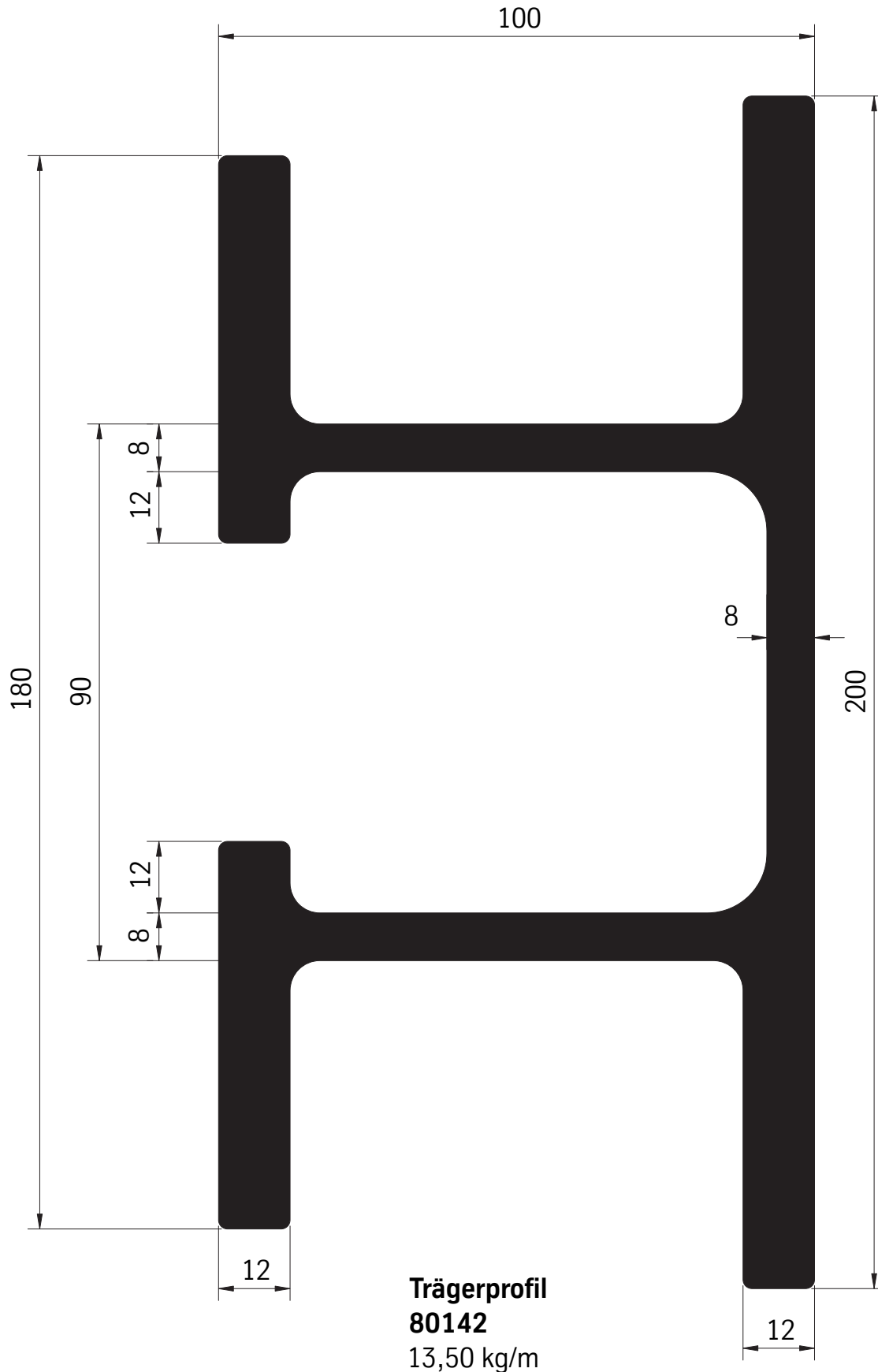

Mulden-System-Profile

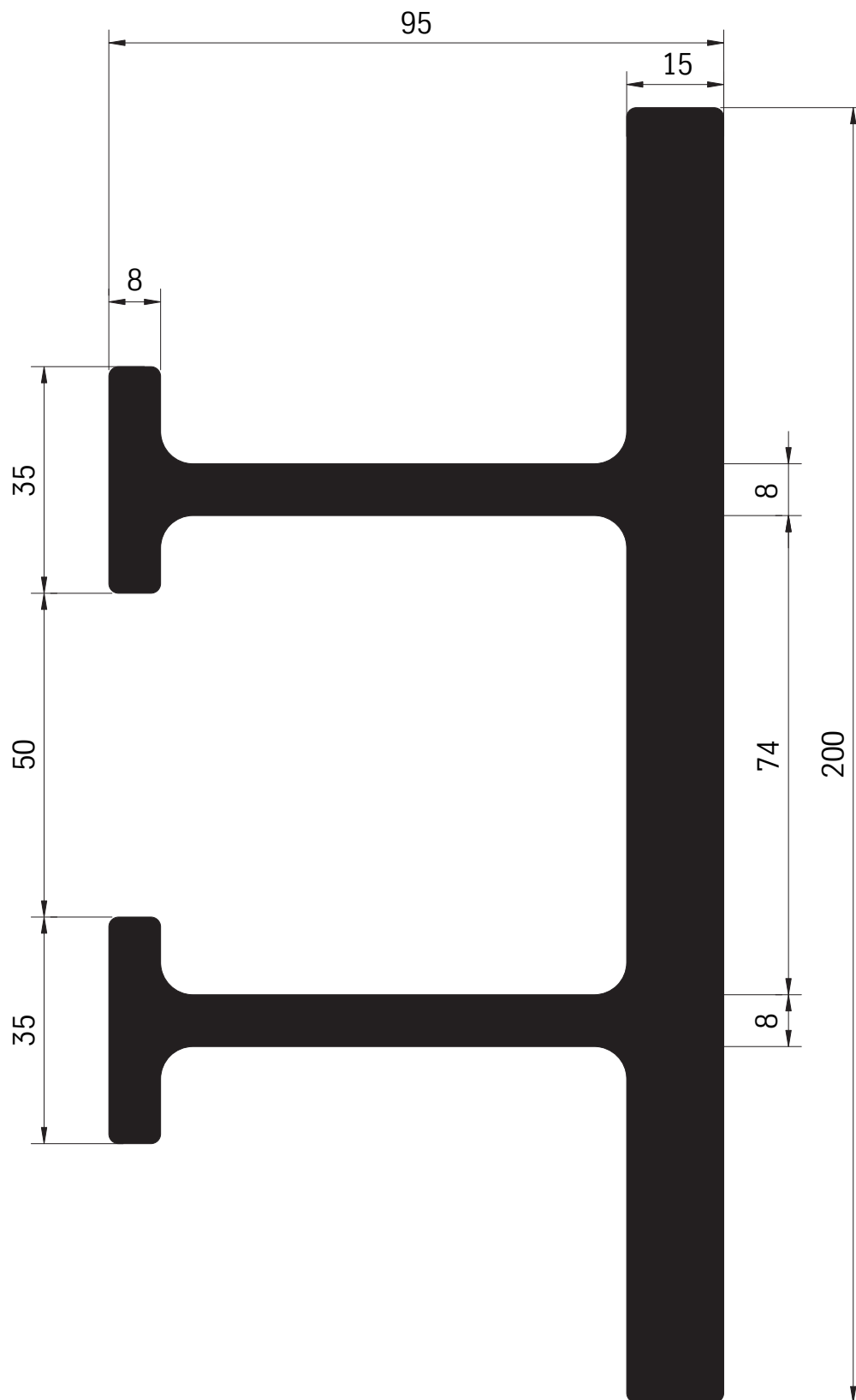

Trägerprofil
80143
12,80 kg/m

Mulden-System-Profile

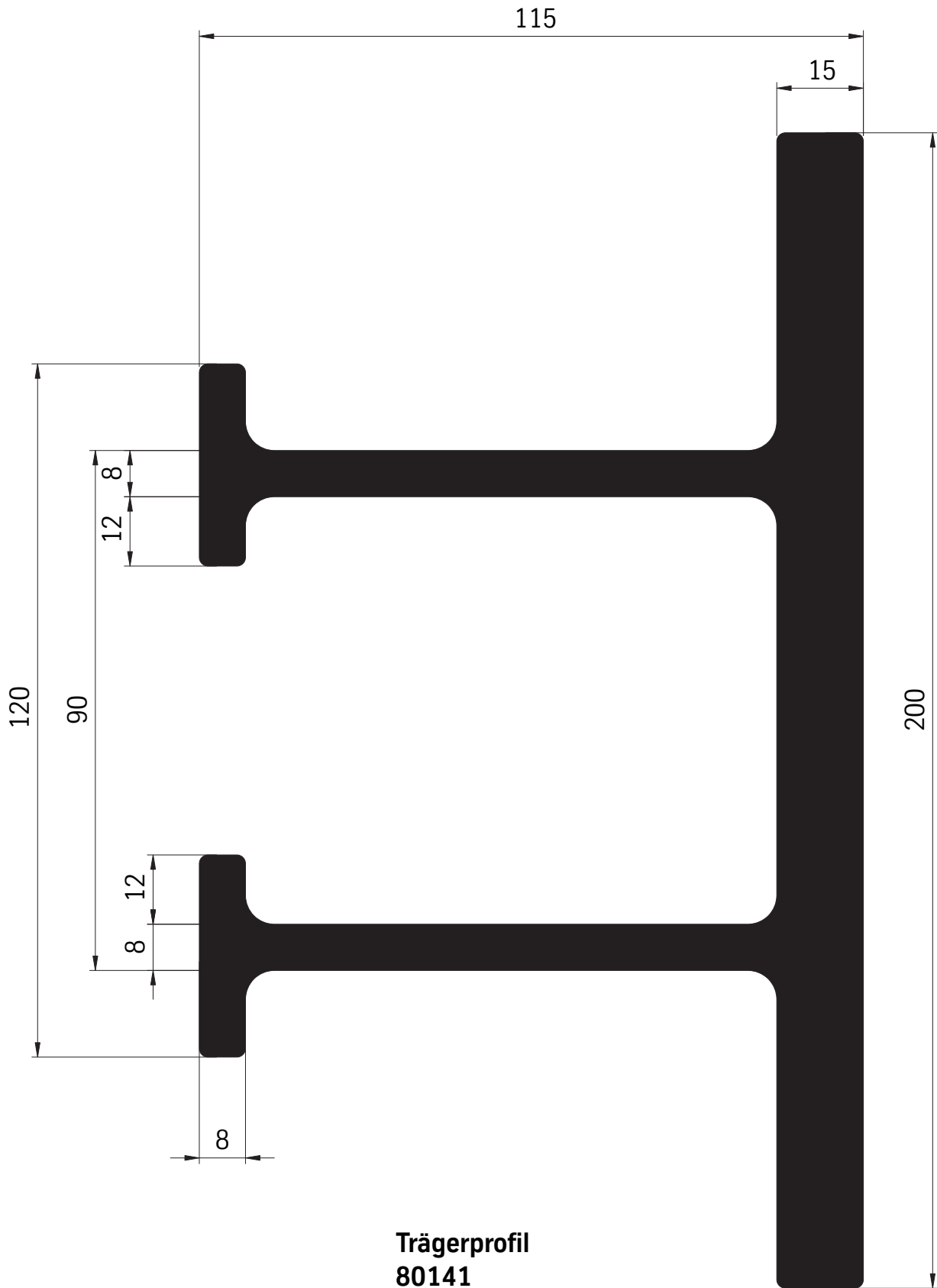

Trägerprofil
80141
13,80 kg/m

Mulden-System-Profile

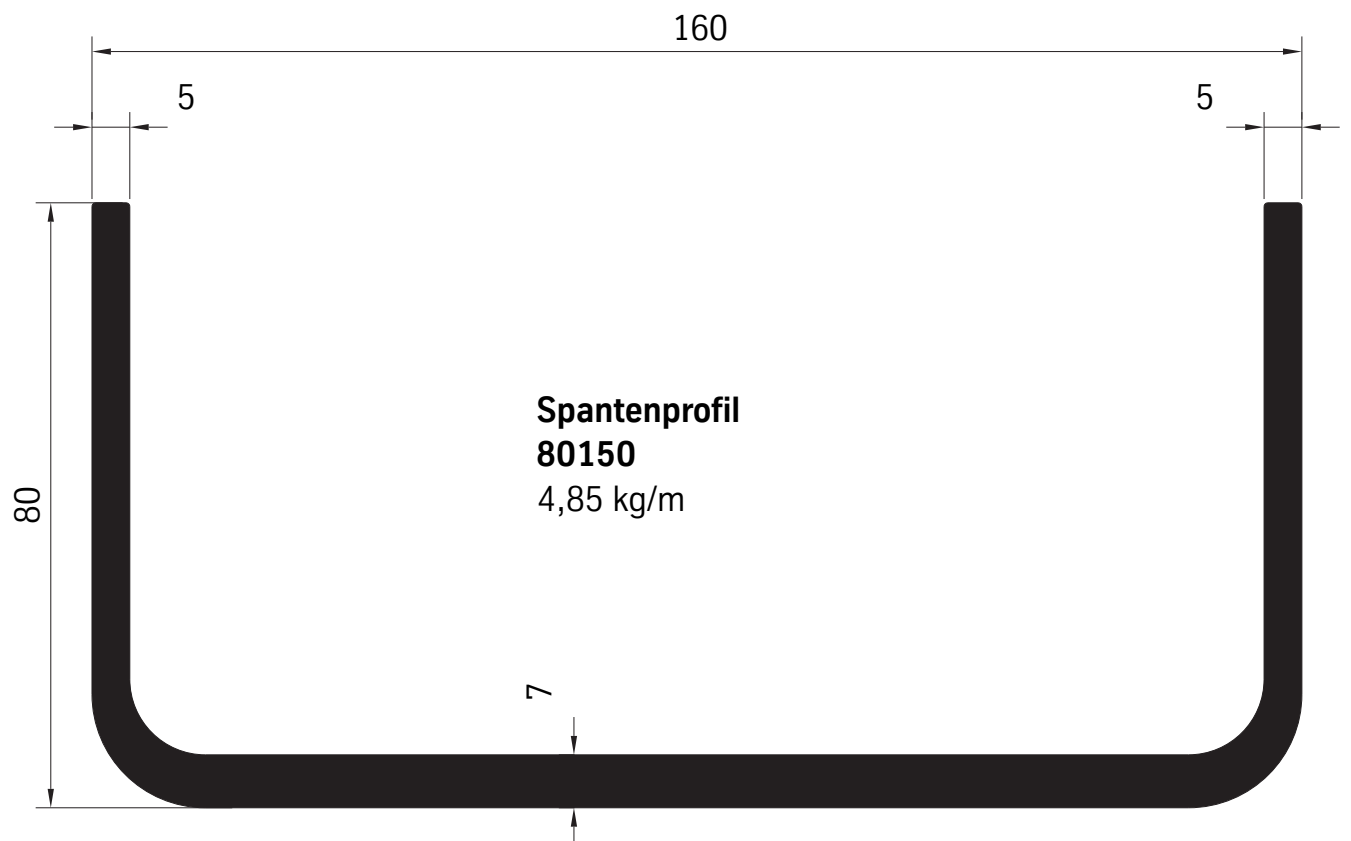
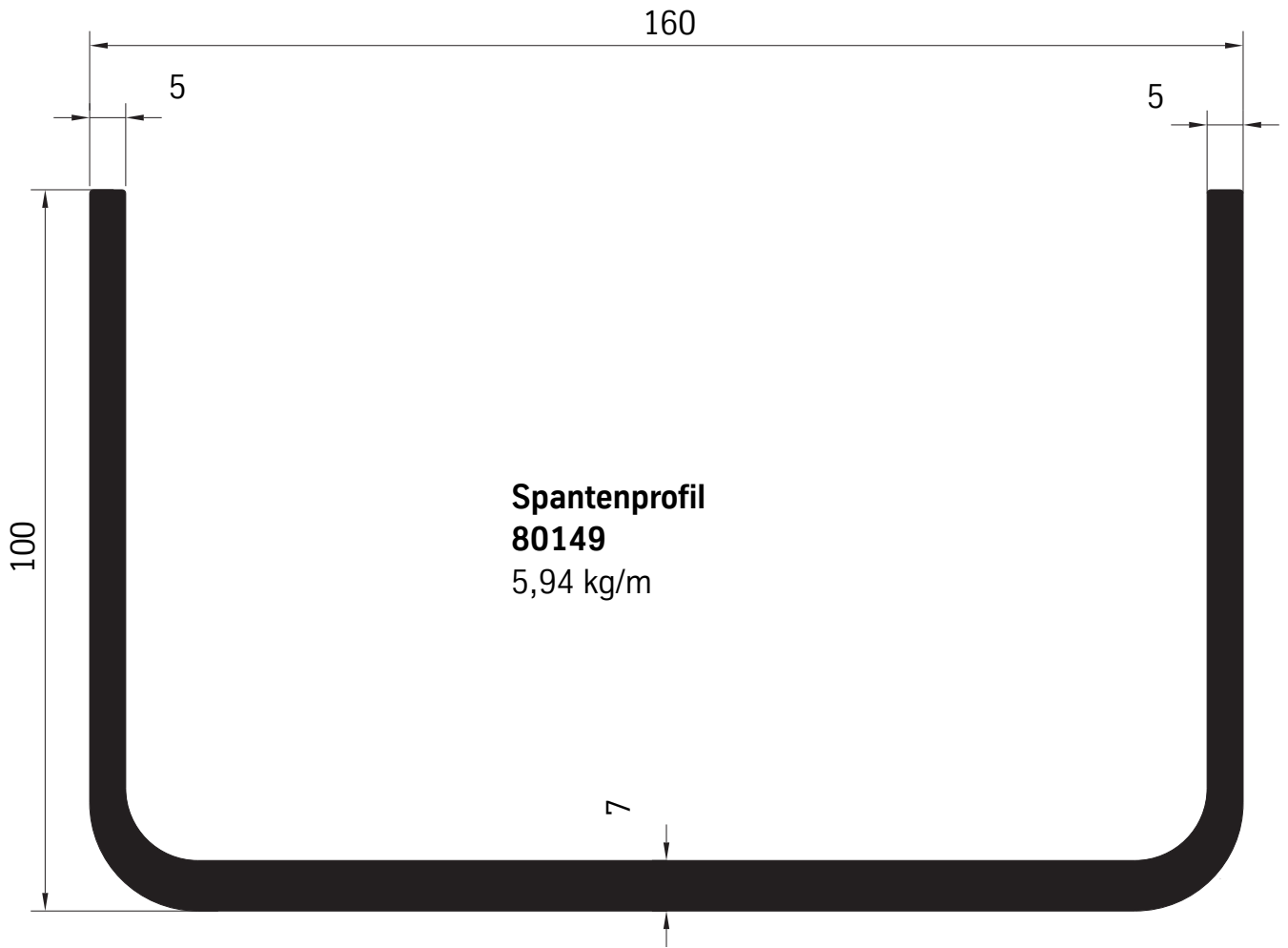

Mulden-System-Profile

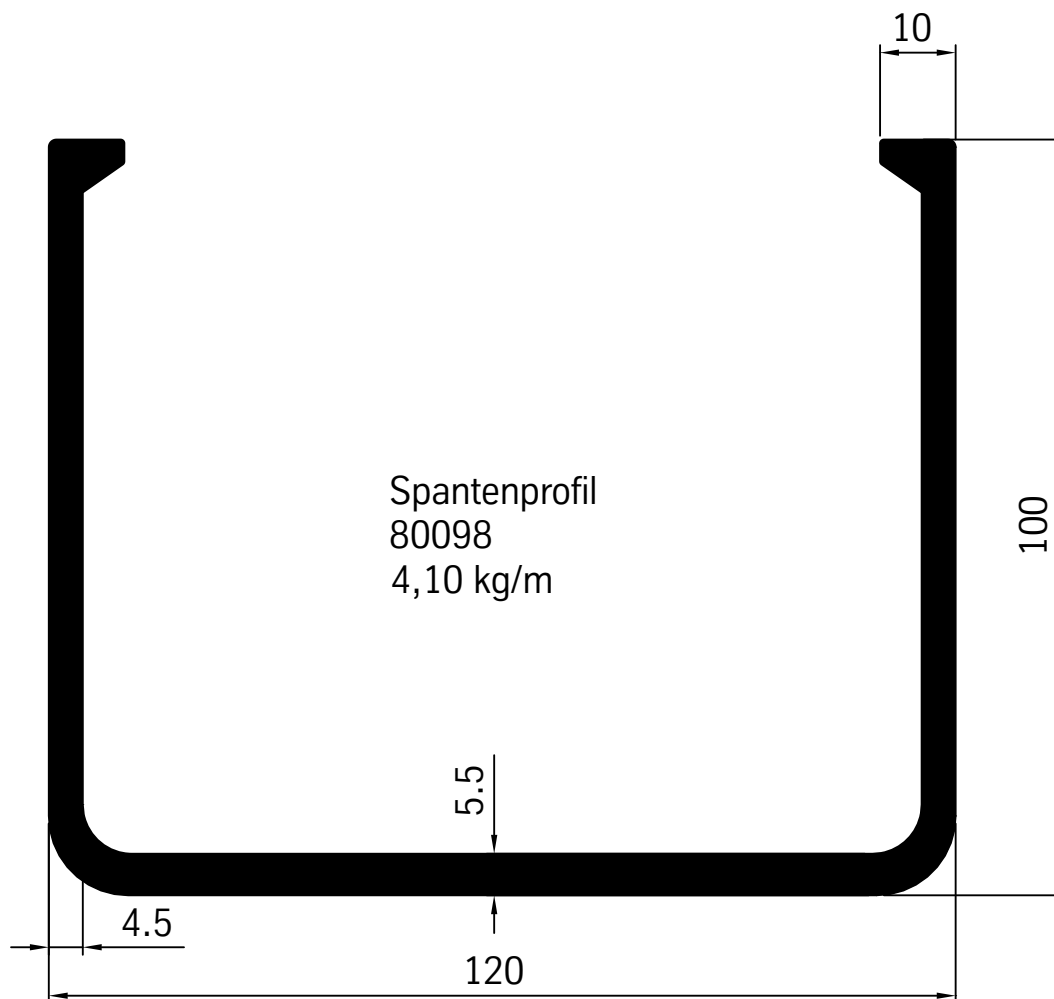
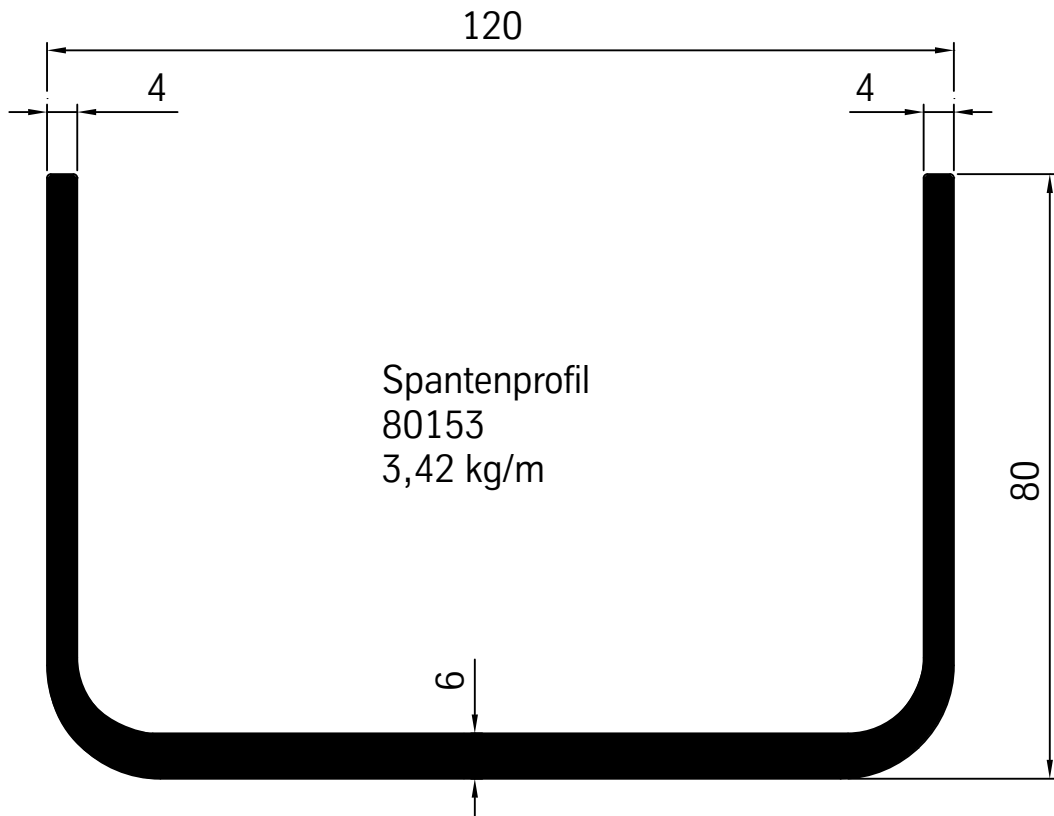

Mulden-System-Profile

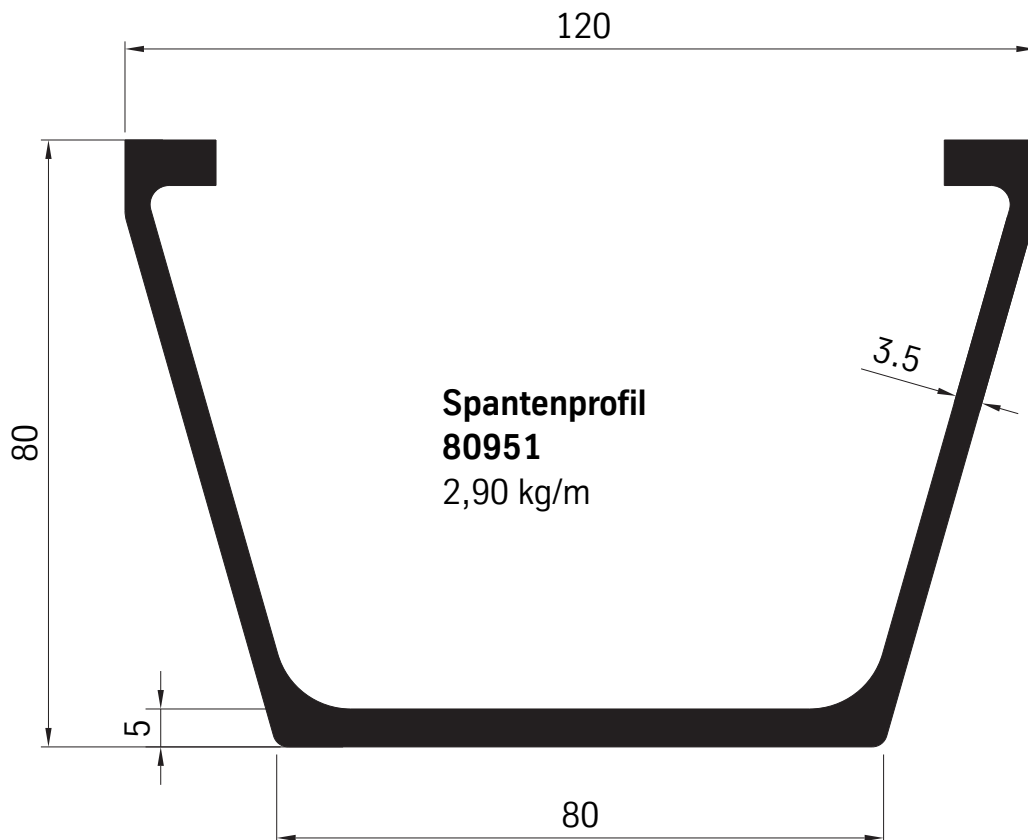
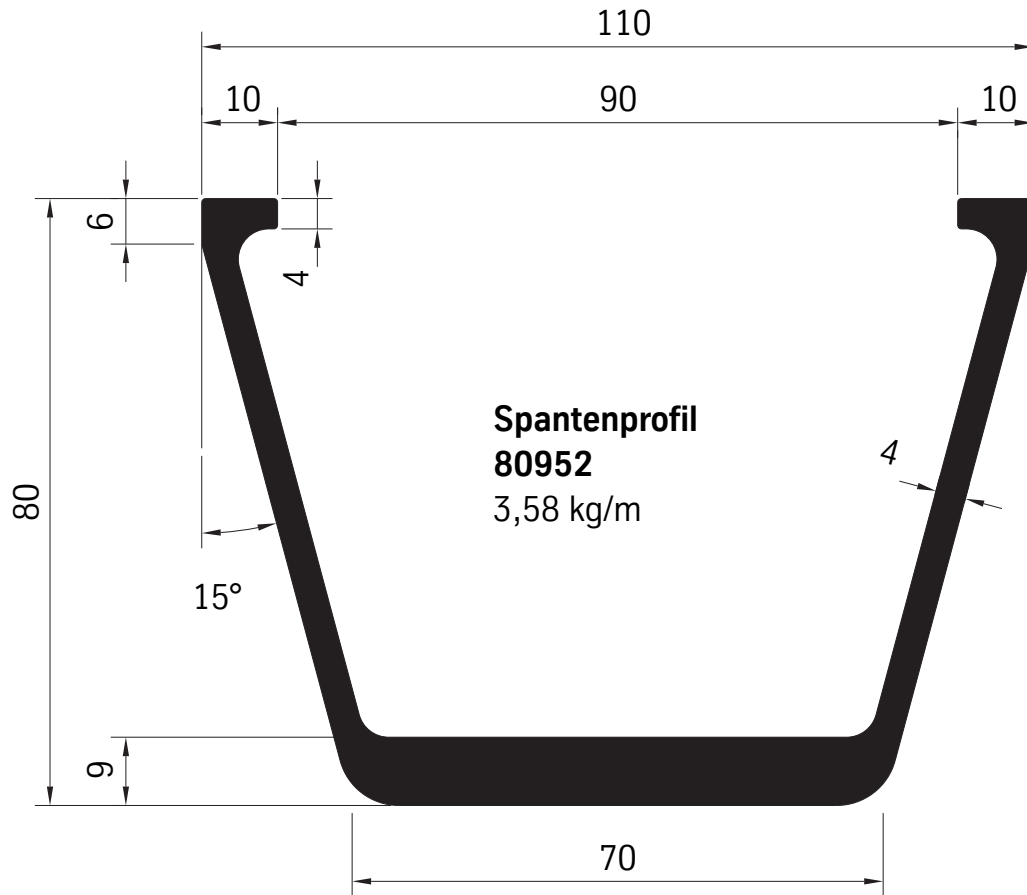

Mulden-System-Profile

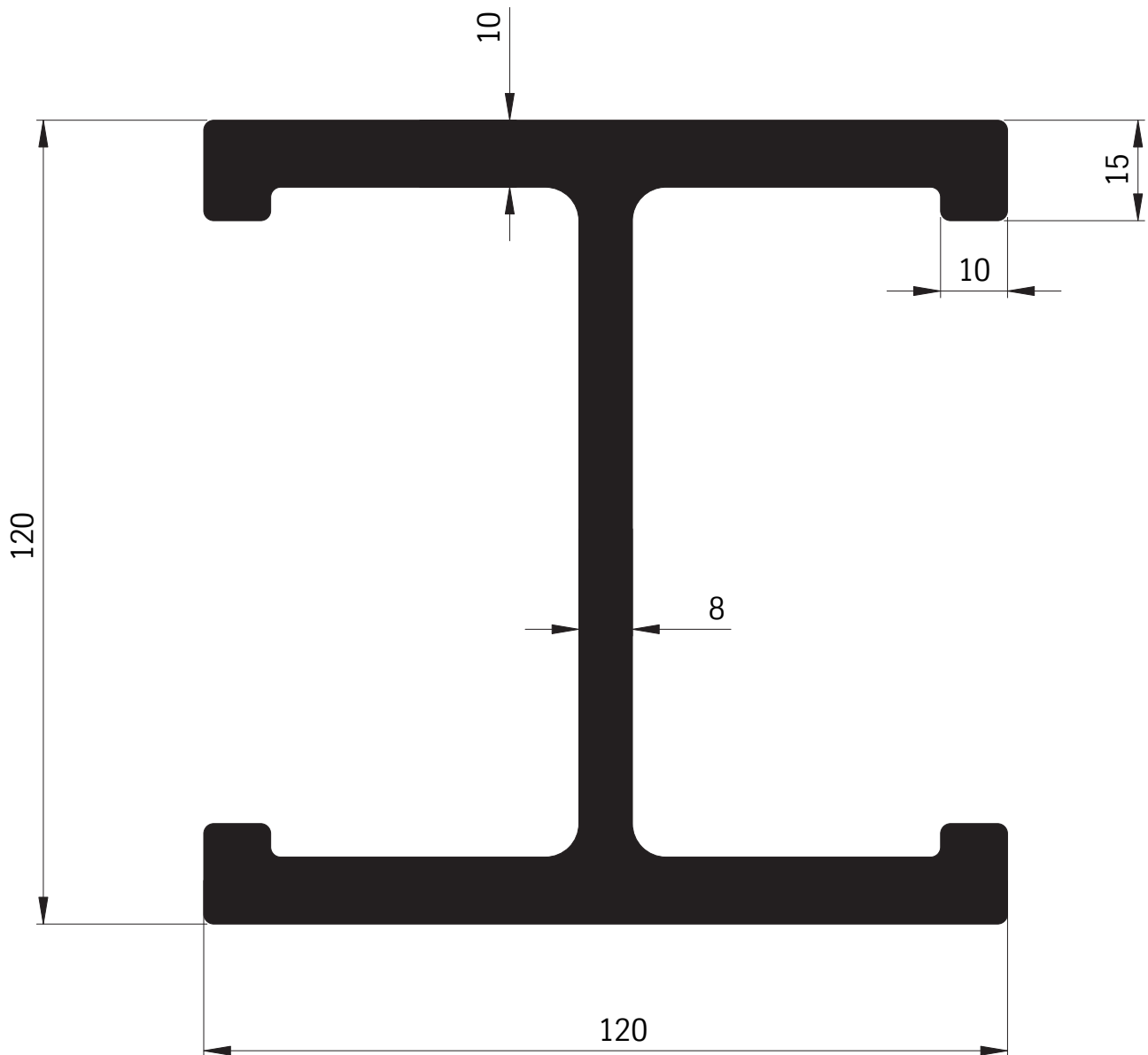

Querträgerprofil

80120

9,40 kg/m

Mulden-System-Profile

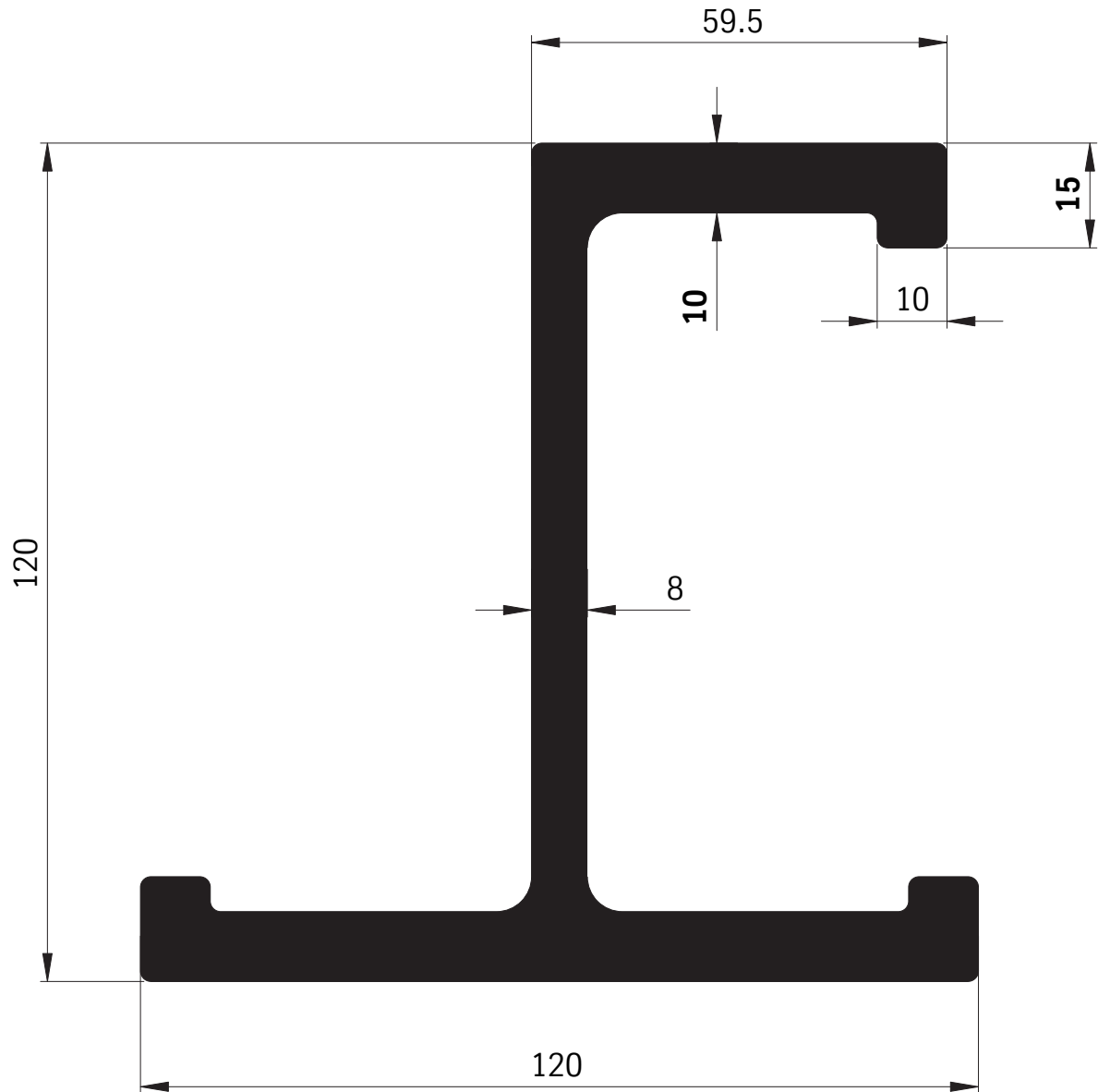

Querträgerprofil

80121

7,60 kg/m

Mulden-System-Profile

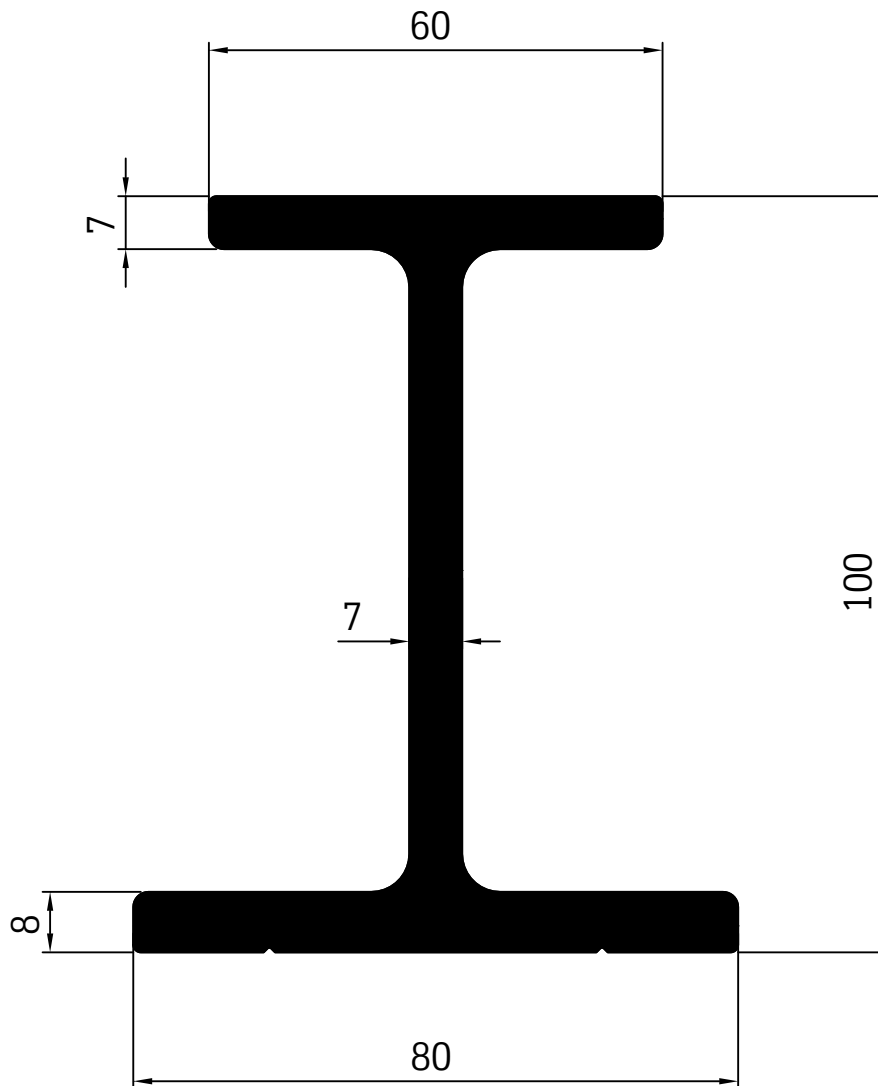

Querträgerprofil
80122
4,65 kg/m

Mulden-System-Profile

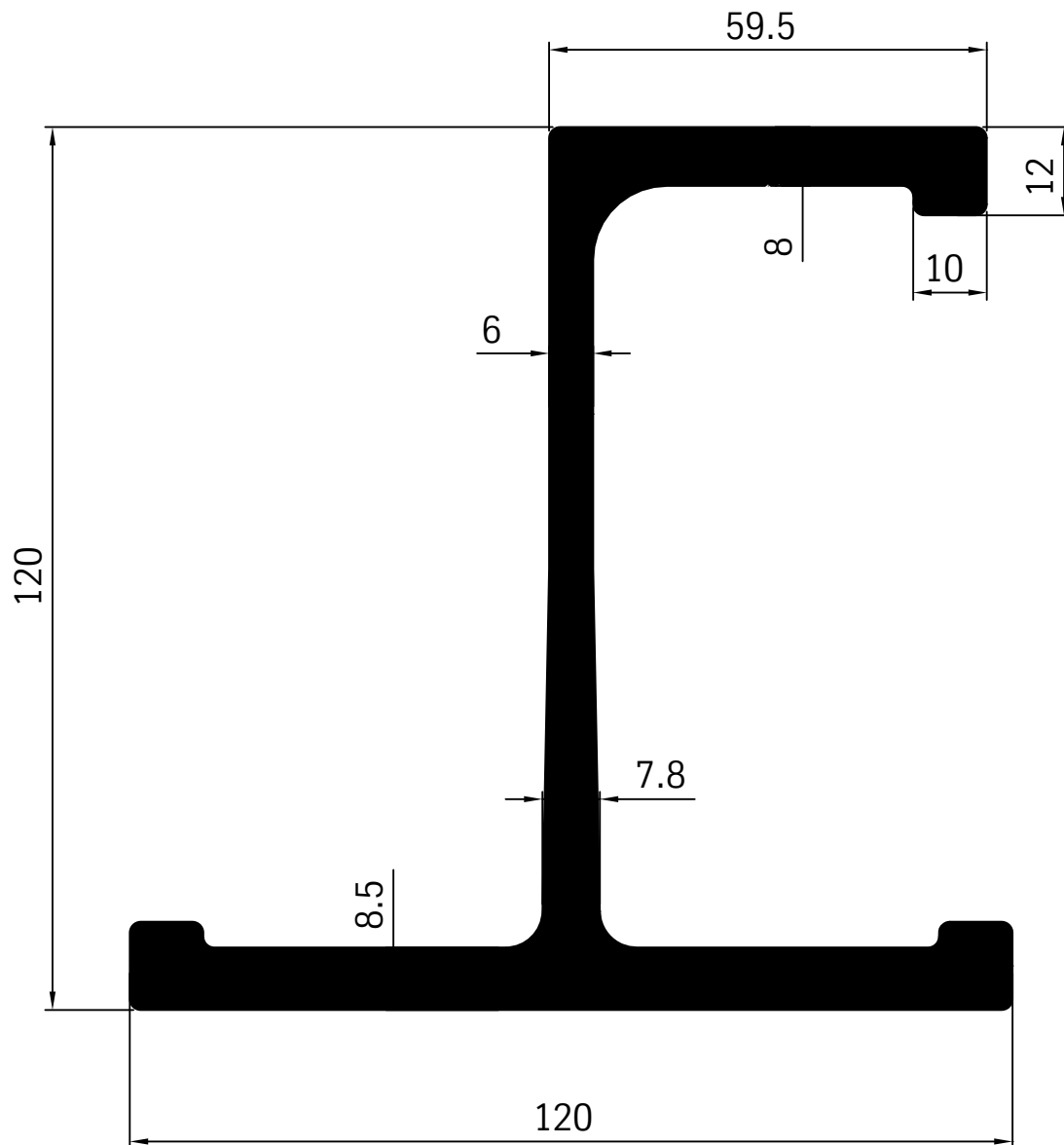

Querträgerprofil
80123
6,30 kg/m

Mulden-System-Profile

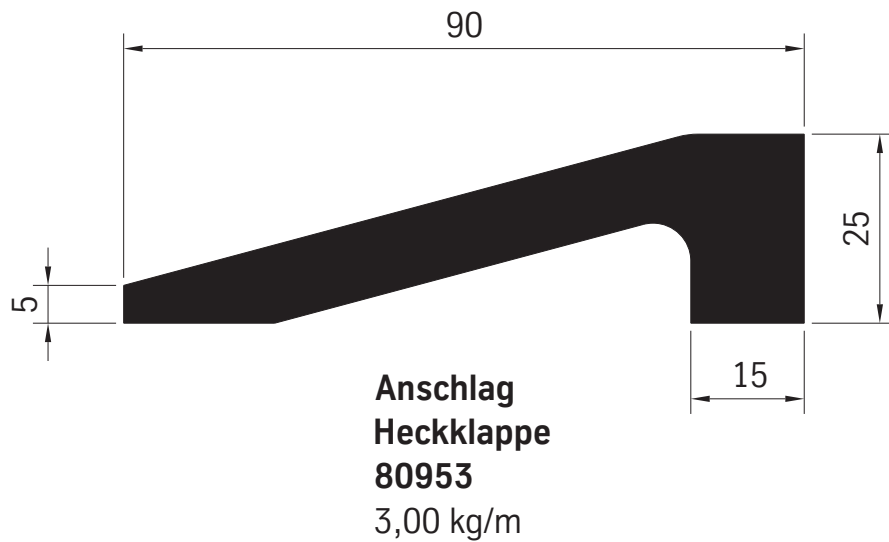
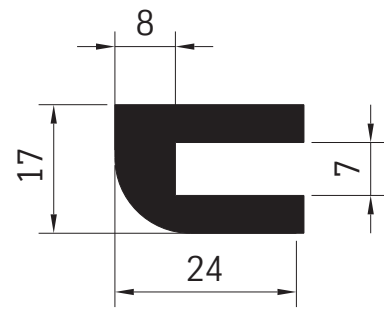
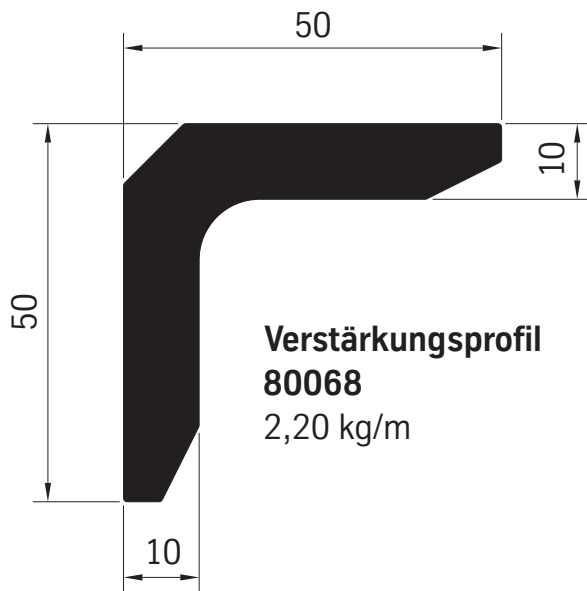
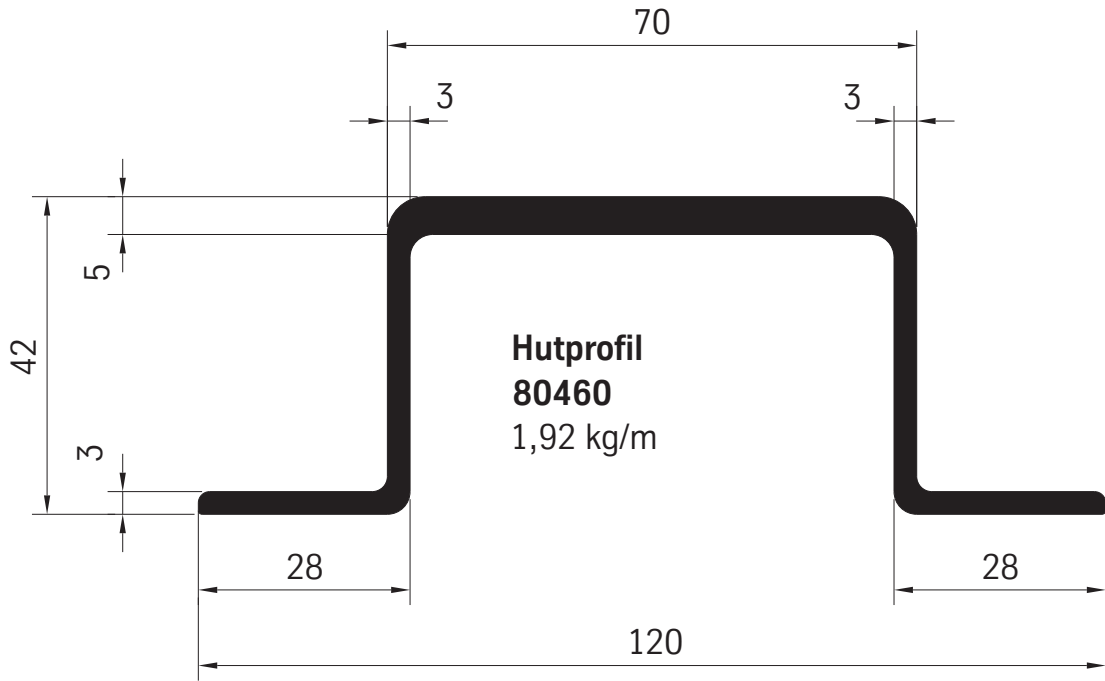

Mulden-System-Profile

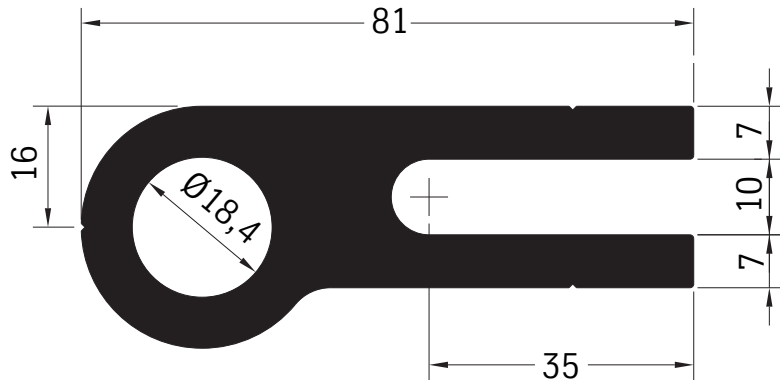

**Scharnierprofil
80064**
3,74 kg/m



**Scharnierprofil
80911**
5,00 kg/m

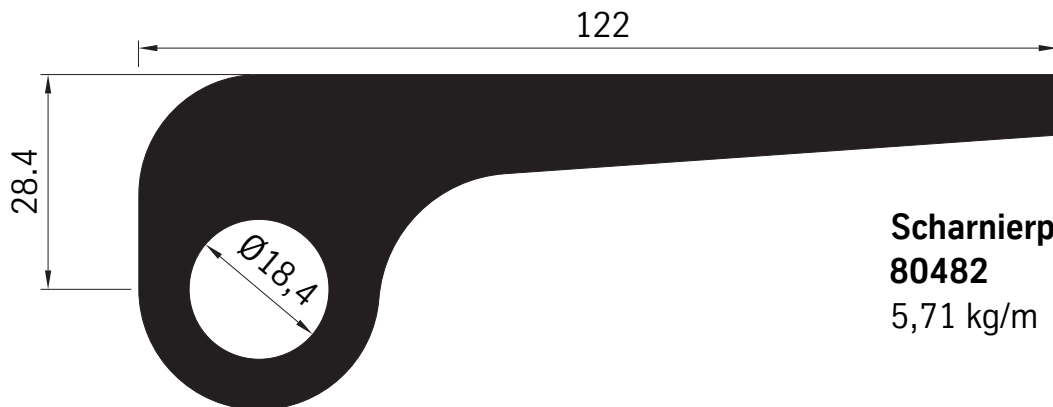

**Scharnierprofil
80482**
5,71 kg/m

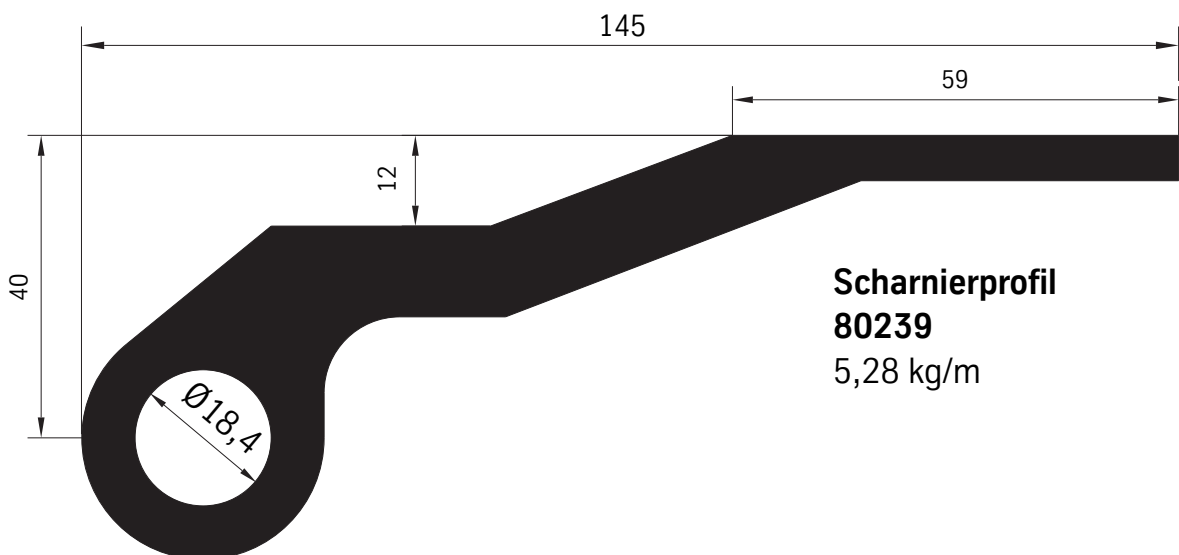

**Scharnierprofil
80239**
5,28 kg/m

Mulden-System-Profile

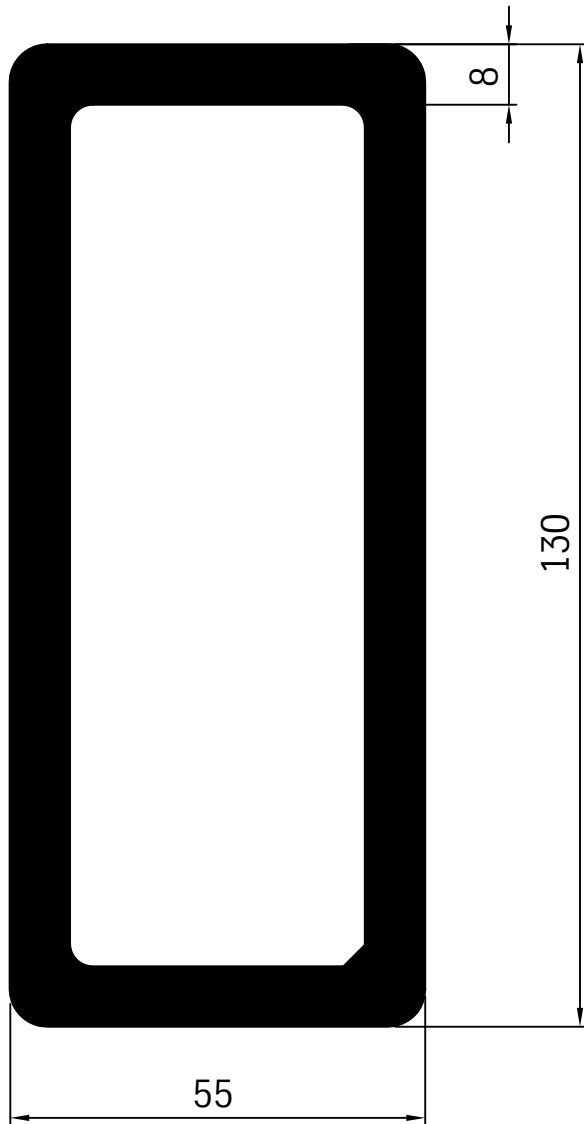

Vierkantrohr
80734
7,30 kg/m

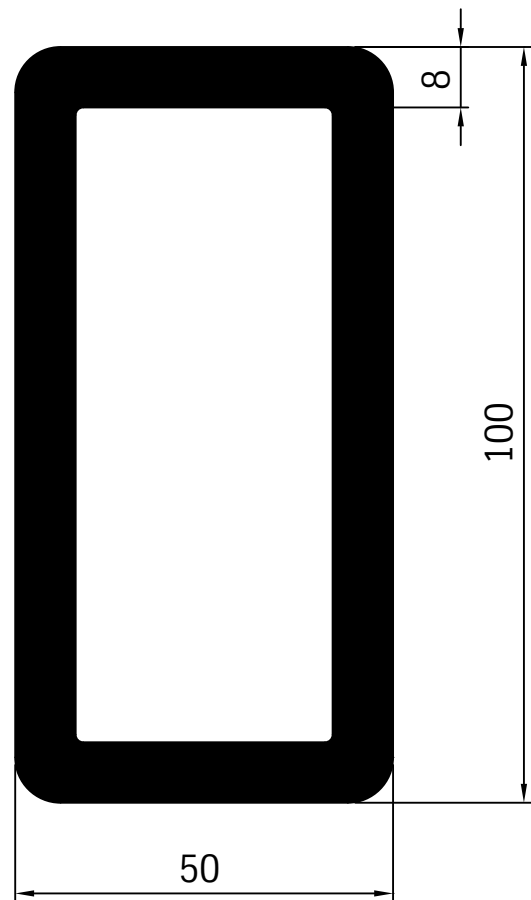

Vierkantrohr
80148
5,72 kg/m

Mulden-System-Profile

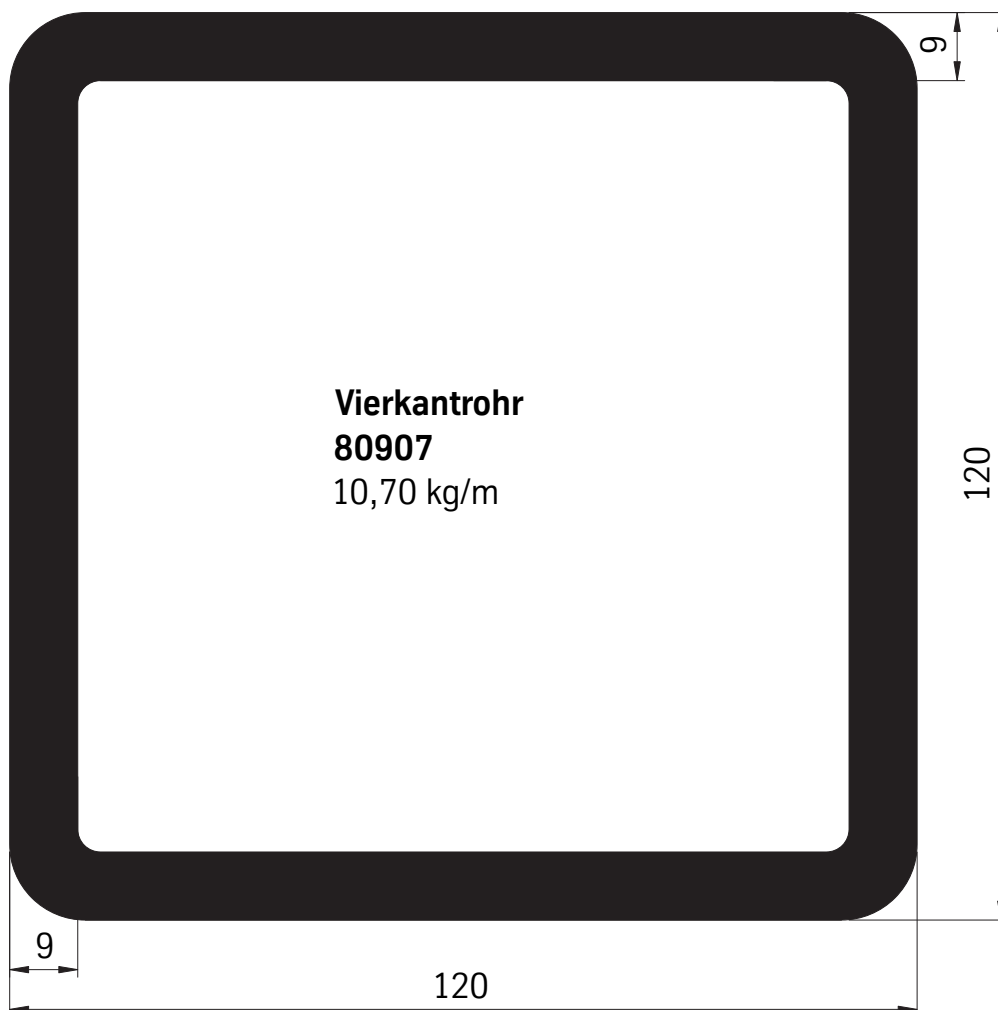
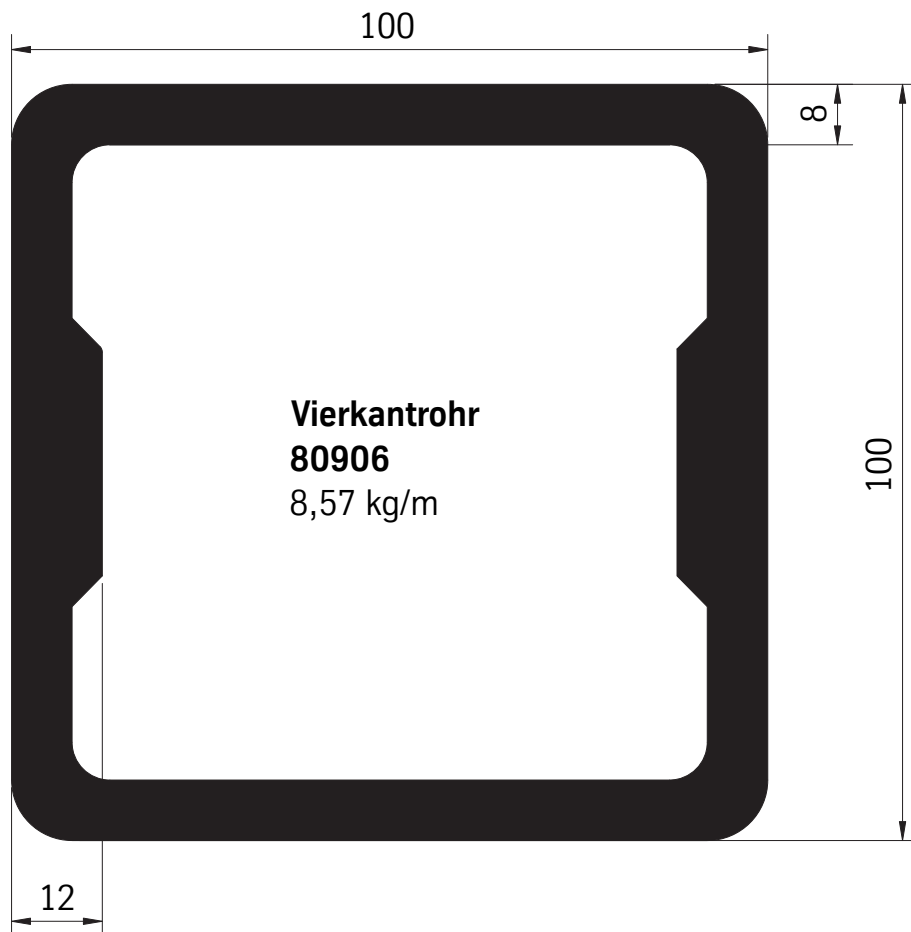

Mulden-System-Profile

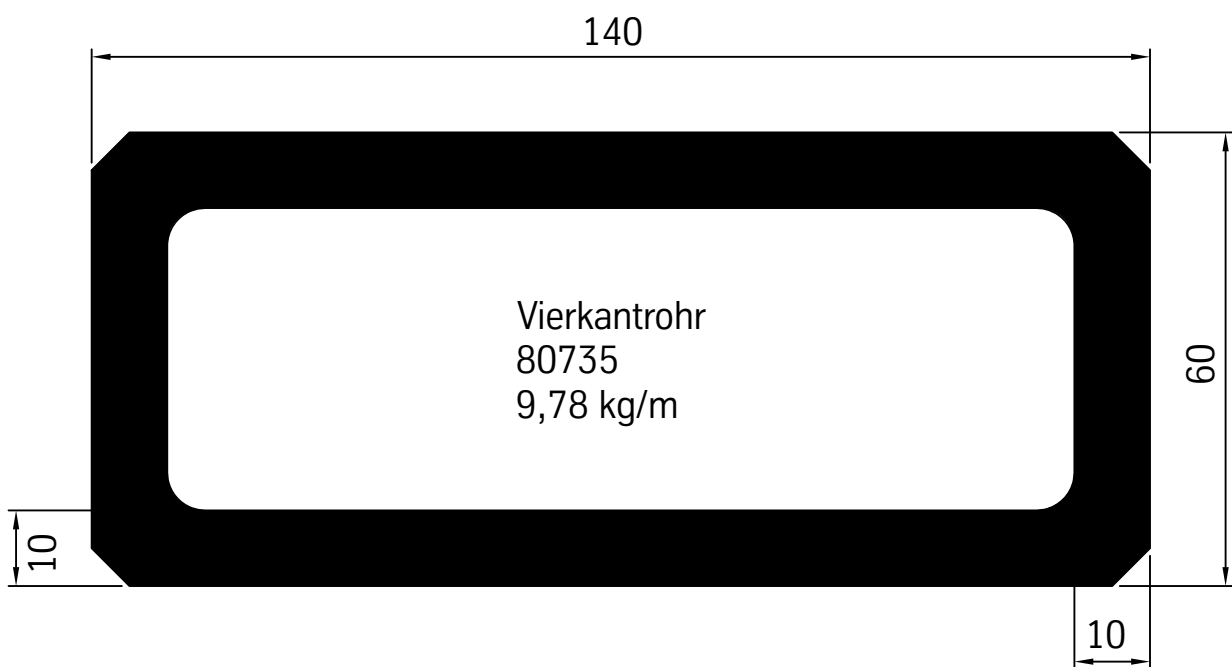
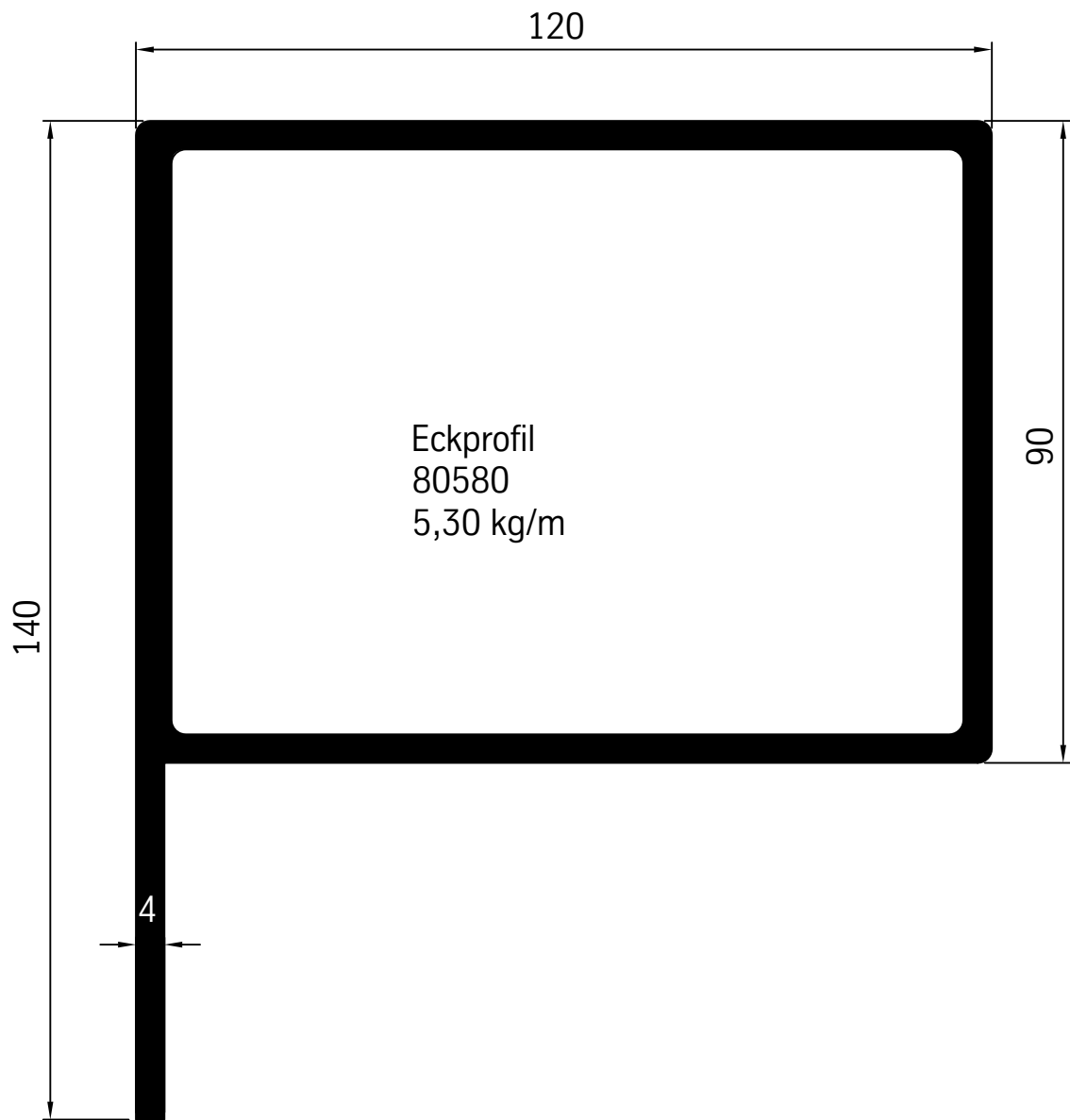

Fahrgestell-System-Profile

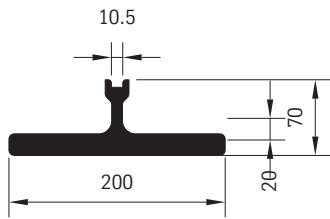

**Trägerprofil
80456**
12,96 kg/m

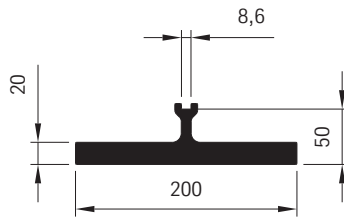

**Trägerprofil
80457**
12,22 kg/m

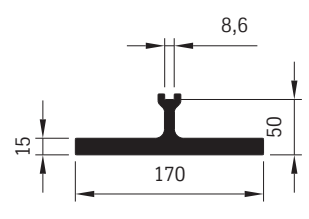

**Trägerprofil
80458**
8,40 kg/m

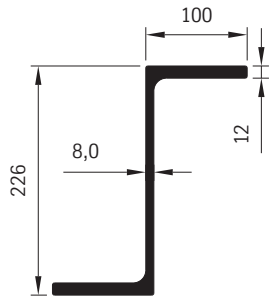

**Z-Profil
80352**
11,02 kg/m

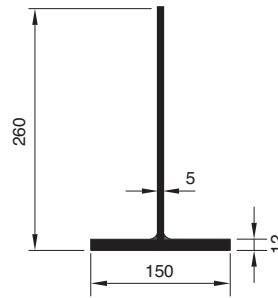

**Trägerprofil
80260**
8,38 kg/m

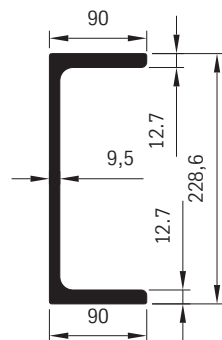

**U-Profil
80230**
11,88 kg/m

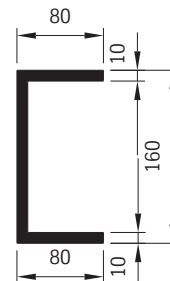

**U-Profil
80160**
8,20 kg/m

Fahrgestell-System-Profile

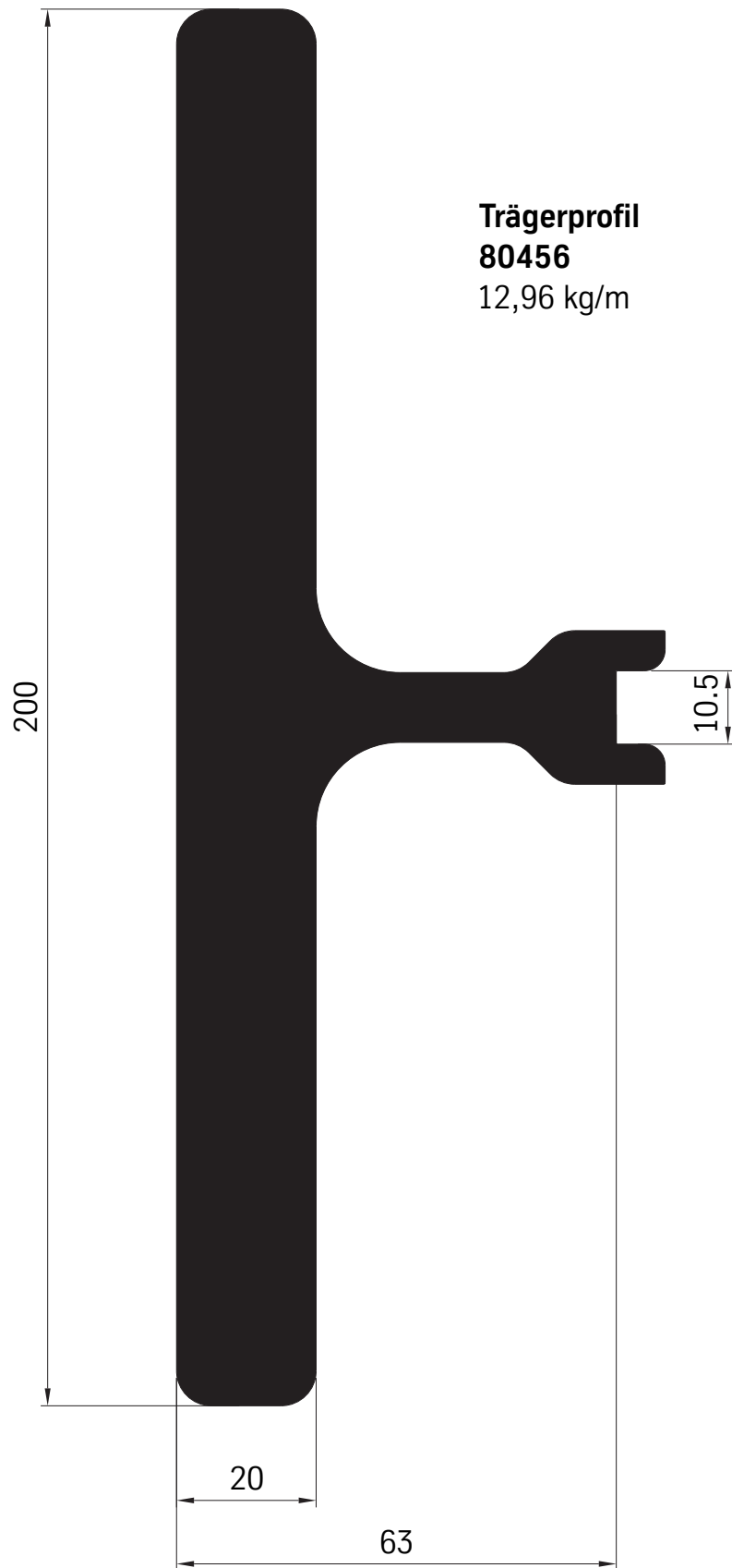

Fahrgestell-System-Profile

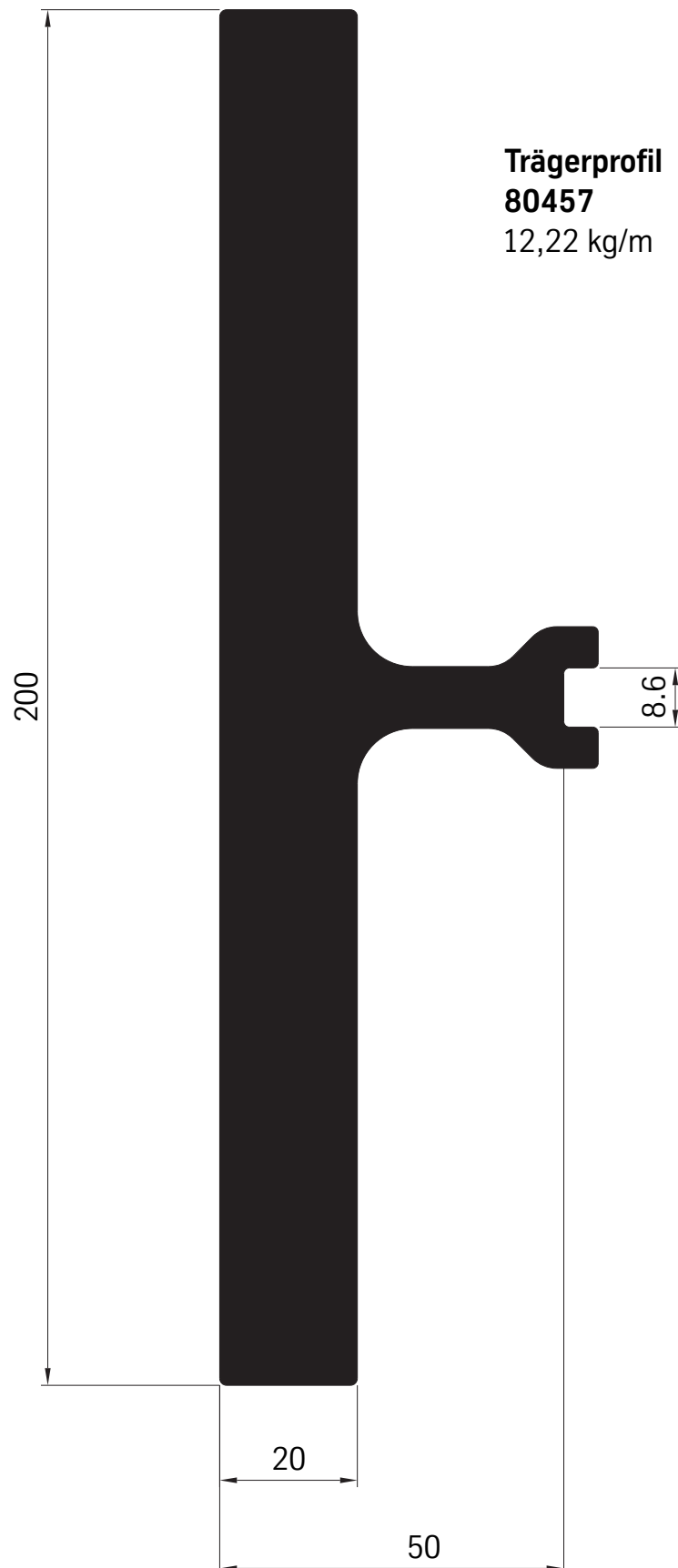

Fahrgestell-System-Profile

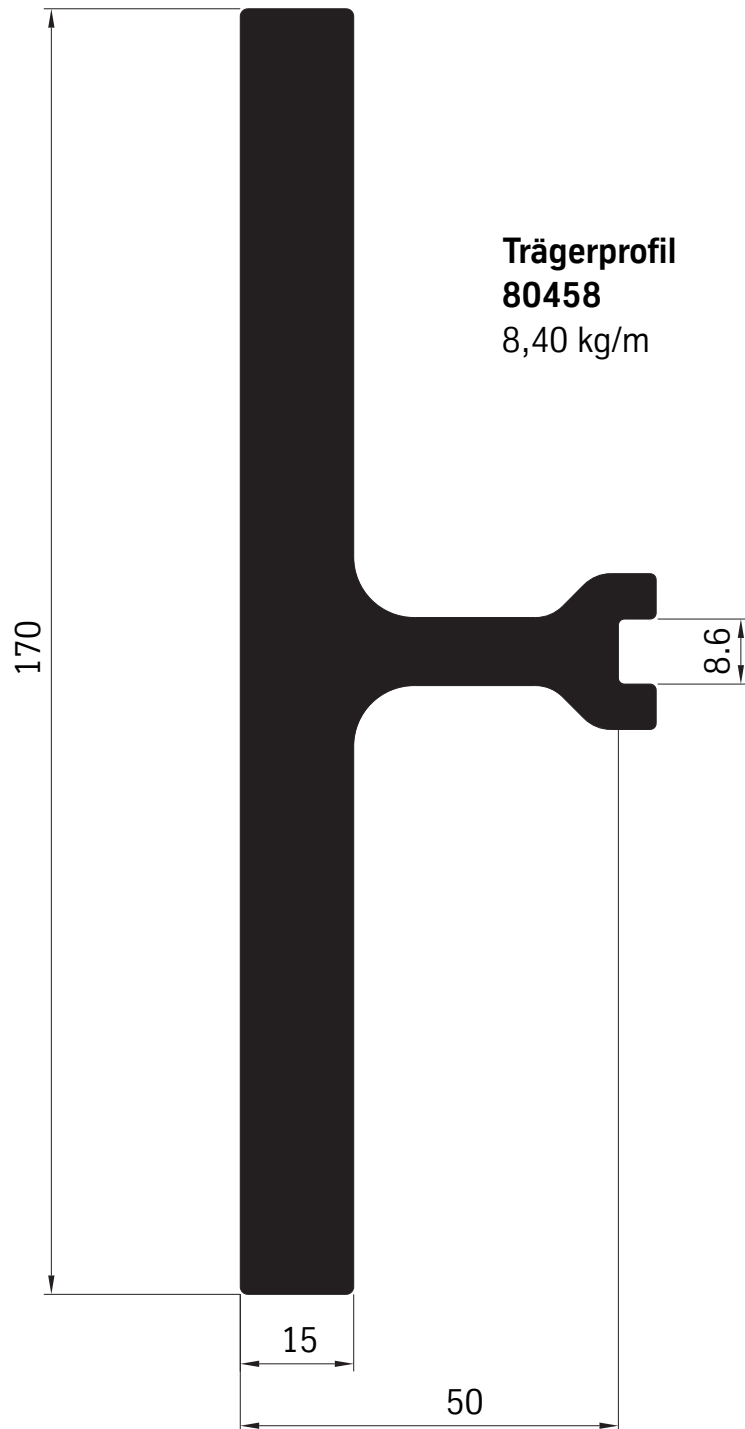

Fahrgestell-System-Profile

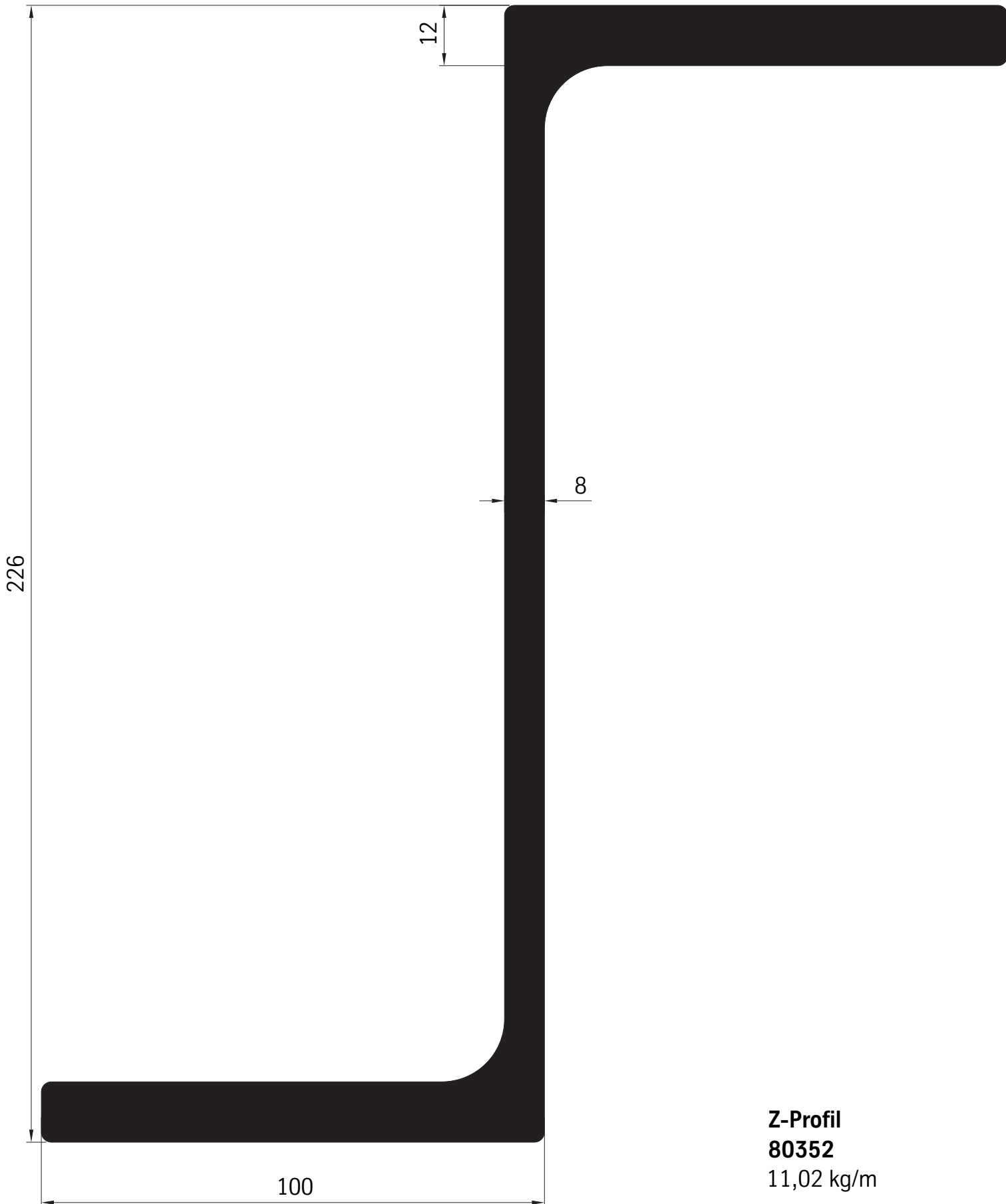

Z-Profil
80352
11,02 kg/m

Fahrgestell-System-Profile

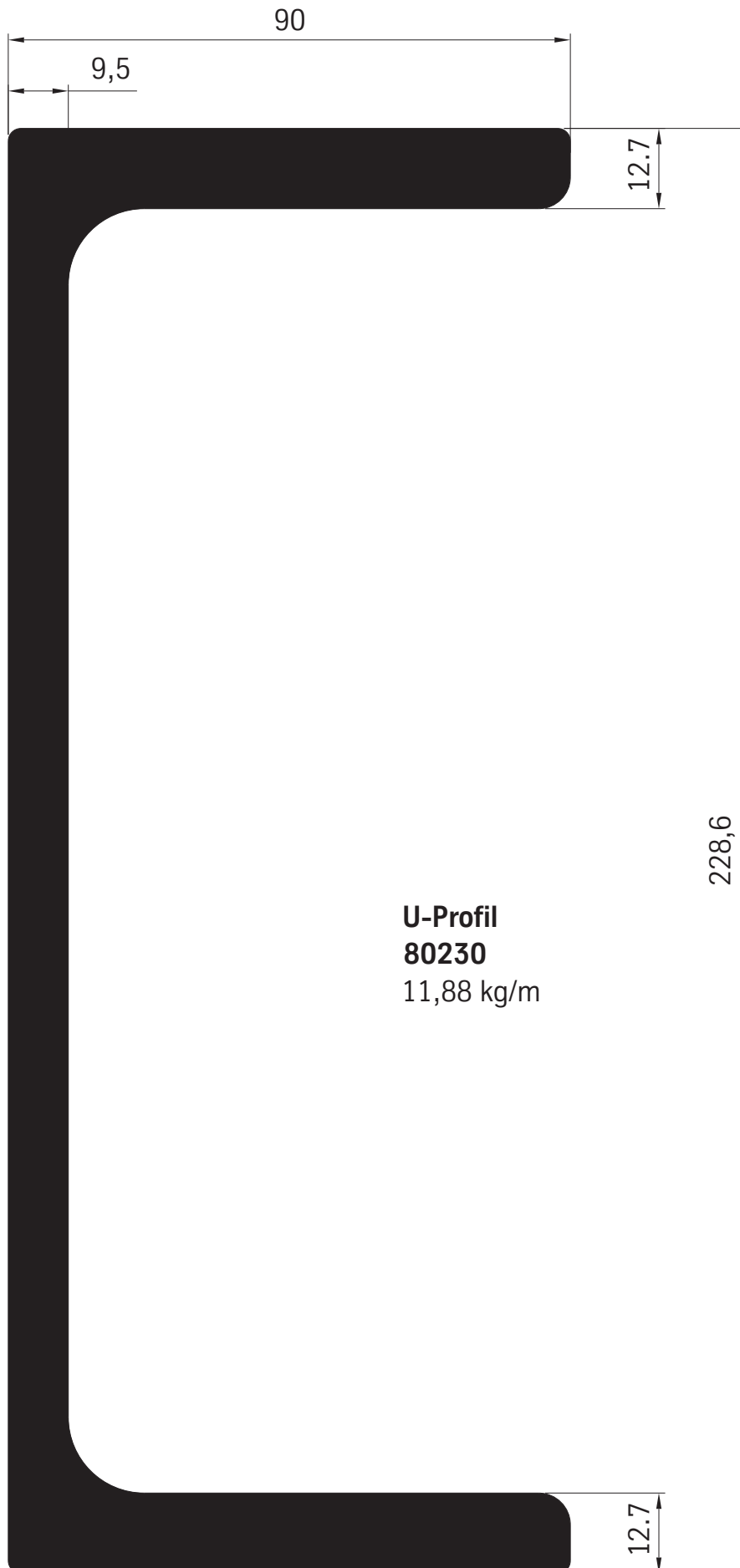

U-Profil
80230
11,88 kg/m

Fahrgestell-System-Profile

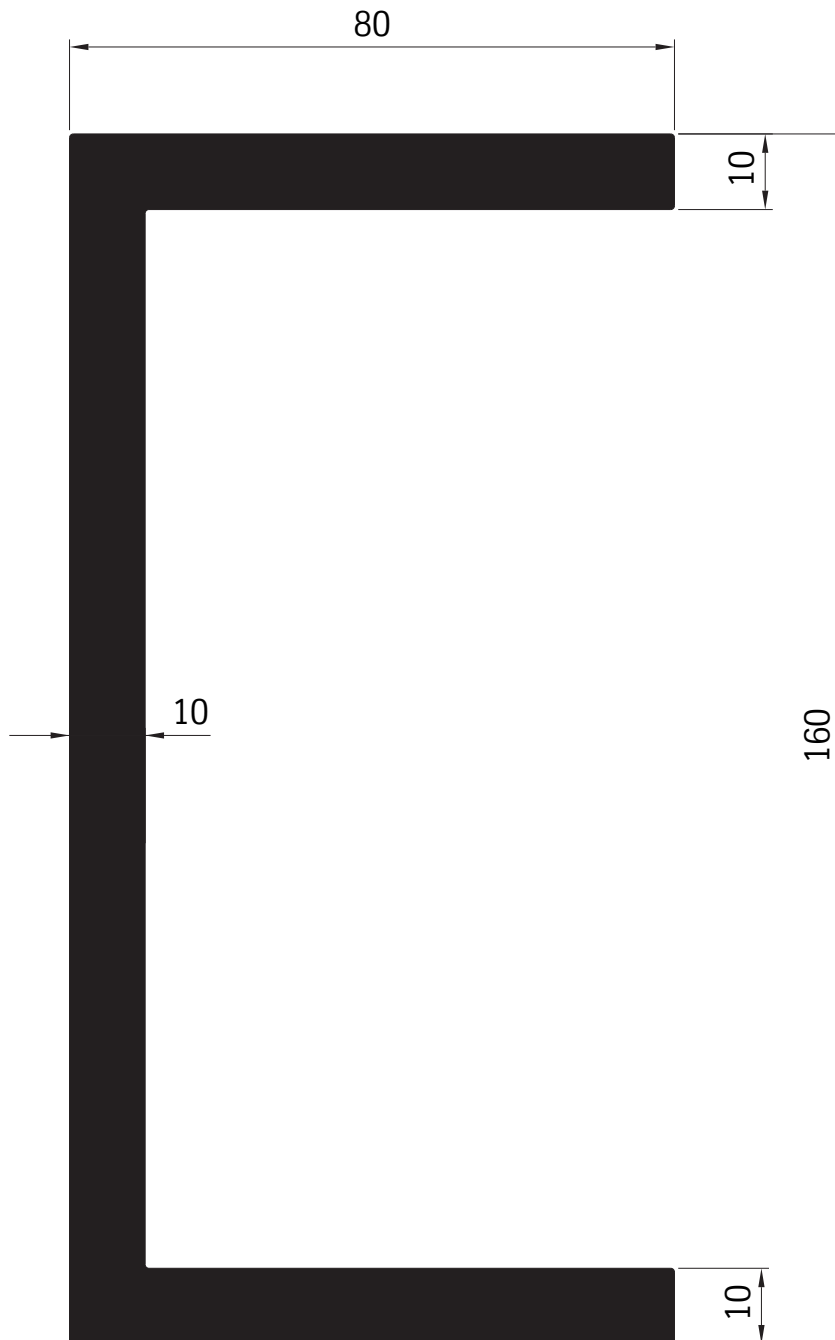

U-Profil
80160
8,20 kg/m

Fahrgestell-System-Profile

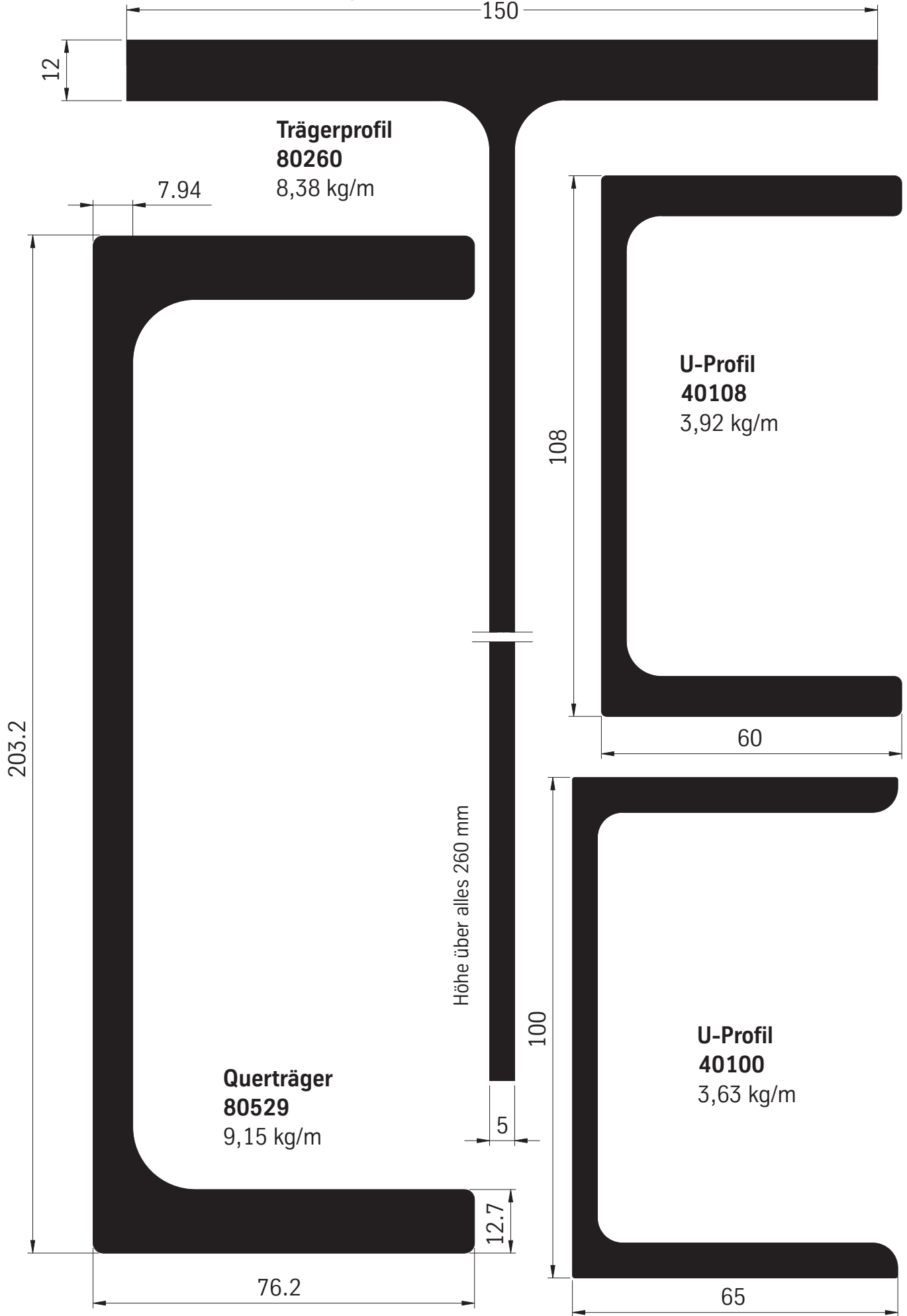

Fahrgestell-System-Profile

